

Entradas de cabos e Proteção de cabos



Sinais e símbolos

Os seguintes sinais e símbolos irão ajudá-lo na orientação do nosso catálogo e assim conseguir especificar as informações exatas do produto.

Type	WISKA-tipo		Diâmetro do cabo sob a armadura/ malha de dentro
WISKA-No.	WISKA-número do Código do Produto		Número de Cabos
WISKA-No. RAL 3000 RD	WISKA-Código do Produto, vermelho fogo		Tamanho da Chave
WISKA-No. RAL 7001 SG	WISKA-Código do Produto, cinza prata		Tamanho da Chave 1
WISKA-No. RAL 7031 BG	WISKA-Código do Produto, cinza azul		Tamanho da Chave 2
WISKA-No. RAL 7035 LG	WISKA-Código do Produto, cinza claro	l/h	Fluxo de ar (litros por hora, 70mbar)
WISKA-No. RAL 9001 WH	WISKA-Código do Produto, branco creme		Prensa Cabos
WISKA-No. RAL 9005 BK	WISKA-Código do Produto, preto	NW	Largura nominal
	Unidades por pacote	B (mm)	Largura
	Diâmetro da rosca de conexão	ED (mm)	Diâmetro externo
	Diâmetro externo da rosca de conexão	VD (mm)	Diâmetro do fechamento
	Diâmetro interno da rosca de conexão		Diâmetro do Furo
	Comprimento da rosca de conexão		Parede
TL (mm)	Comprimento total		Furo de Fixação
	Diâmetro do cabo	E (mm)	Extremidades/Cantos
	Diâmetro do cabo sob a armadura/ malha de fora		Raio da curvatura

Conteúdo

Prensa Cabos		7	PLÁSTICO
Prensa Cabos de plástico e Acessórios			
Prensa Cabos de metal e Acessórios, latão / aço inoxidável / zinco		23	METAL
Prensa Cabos Marítimo e Acessórios, latão		45	MARÍTIMO
Prensa Cabos EMC e Acessórios, latão / aço inoxidável		51	EMC
EX e / i Prensa Cabos e Acessórios, plástico / latão / aço inoxidável		61	EX E/I
EX d Prensa Cabos e Acessórios, latão		80	EX D
Prensa Cabos Ferroviário - Railway (EN 45545) e Recomendados, plástico / latão / aço inoxidável		87	FERROVIÁRIO
Equalização de pressão com ventilação, plástico / latão / aço inoxidável		99	EQUALIZAÇ / VENTILAÇÃO
Prensa Cabos padrão britânico (BS 6121), latão		107	PADRÃO BRITÂNICO
Vedações		111	VEDAÇÕES
Membranas - "tipo prensa cabos/passa-fios"		119	MEMBRANA
CLIXX®, MultiCLIXX®, QUIXX®, FLIP			
Blocos de passagem - MCT - CONMAXX®		123	CONMAXX
Armações, grelhas, juntas de vedação			
CONMAXX® Gland - Ligações roscadas separáveis		130	CONMAXX GLAND
Tubos Corrugados e Terminações Brace® - Proteção de Cabo		131	BRACE FITTING PLÁSTICO
BraceFITTING Acessórios para tubos corrugados, de plástico			
BraceCONDUIT Tubos corrugados de plástico		144	BRACE CONDUIT PLÁSTICO
BraceFITTING Acessórios para mangueiras de metal		153	BRACE FITTING METAL
BraceCONDUIT Mangueiras de protecção em metal		154	BRACE CONDUIT METAL

NOSSA HERANÇA SEU BENEFÍCIO



Fundada em 1919 em Hamburgo, nós, como fabricante de materiais de instalação de navios, conhecemos o clima rigoroso na costa e os desafios para o homem e material. Estas condições extremas moldaram as exigências de nossos produtos nestes quase 100 anos. O resultado é que tudo que fabricamos é feito para os ambientes mais difíceis

Esses mercados confiam em nossas sistemas de Entradas de Cabos:

Automação



Geração de energia



Construção naval



Iluminação



Trens



Engenharia mecânica e de instalações



Setor elétrico



Conector e tecnologia de conexão



Instalação elétrica



Distribuição

Produtos fortes de nossa própria produção. Em todas as categorias.

Com a introdução do nossa própria variedade de proteção de cabos e sistema de entrada de cabos, somos o seu provedor e especialista de uma completa Gama de itens. Sempre quando se falar de inserção onde os cabos vão! Os prensa cabos que respiram, inserções de

membrana macia, e até mesmo para suportar o mais forte tranco, ou desafio de proteção do cabo, até as temperaturas mais extremas. Onde seus cabos forem, nossos produtos suportarão as suas mais altas reivindicações.



Prensa Cabos

Tão versátil quanto suas aplicações.



Membranas de borracha

Mais rápido e mais fácil que os prensa cabos. Tipo passa-fio.

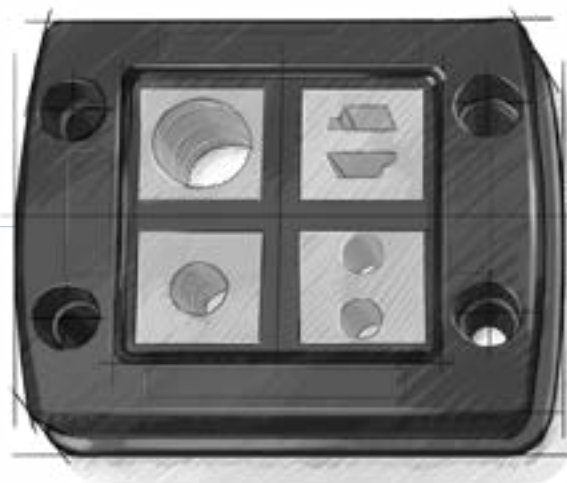

Blocos de Passaem - MCT

Reune. Mantém juntos.



Tubos Corrugados e Terminações

Proteção de cabo para as condições mais duras.

Qualidade vem de boa parceria.

Em Kaltenkirchen trabalhamos a todo momento com nosso Autoconceito como fornecedor de soluções para fazer os melhores produtos possíveis, com alta qualidade. Nosso desenvolvimento e o departamento de design está sempre procurando dar aos clientes aquilo que eles precisam. Com foco trabalhamos lado a lado com eles, e junto com o Departamento de produção usamos materiais de alta qualidade. Com nosso próprio parque de produtivo.

Com nosso Laboratório de teste interno , podemos garantir que os produtos recebam nossos altos padrões de qualidade. Nós somos um parceiro que esta sempre ao alcance dos seus olhos de nossos clientes. Com uma equipe de consultoria e vendas.

Temos uma rede mundial de subsidiárias e Parceiros e contratados , aconselhamos a qualquer momento a melhor solução para cada projeto.

Nossa compreensão de boa cooperação baseia-se em conhecer bem uns aos outros. Criando uma base de confiança sólida que você valoriza ainda mais quando tudo correr como um relógio. Nós vemos assim: escrever bons números juntos é importante. E mais importante, de isso partir de um para o outro de mãos dadas.



Tanja e Ronald Hoppmann, diretores executivos de terceira geração da WISKA



Qualidade Certificada





Prensa Cabos de plástico

Nos anos 1920, foi quando tivemos nosso primeiro prensa cabo plástico produzido. Até hoje fabricamos continuamente em nosso próprio pátio de injeção plástica, perto de Hamburgo, somos especializados em componentes plásticos de alta tecnologia.

Pressa Cabo SPRINT®, ESKV, métrico, EN 62444



ESKV



ESKV-L

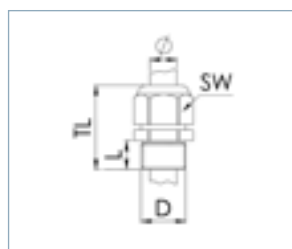

Classe de proteção IP68 (5 bar 30 min) / IP69
Teste de fio incandescente 750 °C
Faixa de temperatura -40 °C - 100 °C
Material Pressa Cabo de Poliamida, Vedação de EPDM

ESKV

Type	WISKA-No. RAL 7035	WISKA-No. RAL 7001	WISKA-No. RAL 9005					TL (mm)	
ESKV 12	10066410	10066380	10066120	M 12x1,5	9	3 - 7	16	29 - 34	50
ESKV 16	10066411	10066381	10066121	M 16x1,5	9	4,5 - 10	20	31 - 37	50
ESKV 20	10066412	10066382	10066122	M 20x1,5	10	6 - 13	24	36 - 45	50
ESKV 20 PLUS	10061789	10061865	10061864	M 20x1,5	10	7,5 - 14	24	36 - 45	50
ESKV 25	10066413	10066383	10066123	M 25x1,5	10	9 - 17	29	38 - 47	50
ESKV 32	10066414	10066384	10066124	M 32x1,5	12	13 - 21	36	42 - 51	25
ESKV 40	10066415	10066385	10066125	M 40x1,5	12	16 - 28	46	52 - 65	10
ESKV 50	10066416	10066386	10066126	M 50x1,5	14	21 - 35	55	59 - 72	4
ESKV 63	10066417	10066387	10066127	M 63x1,5	15	34 - 48	68	64 - 78	3

ESKV-L, longo

Type	WISKA-No. RAL 7035	WISKA-No. RAL 7001	WISKA-No. RAL 9005					TL (mm)	
ESKV-L 12	10066390	10066516	10066500	M 12x1,5	15	3 - 7	16	35 - 40	50
ESKV-L 16	10066391	10066517	10066501	M 16x1,5	15	4,5 - 10	20	37 - 43	50
ESKV-L 20	10066392	10066518	10066502	M 20x1,5	15	6 - 13	24	41 - 50	50
ESKV-L 25	10066393	10066519	10066503	M 25x1,5	15	9 - 17	29	43 - 52	50
ESKV-L 32	10066394	10066520	10066504	M 32x1,5	15	13 - 21	36	45 - 54	25
ESKV-L 40	10066395	10066521	10066505	M 40x1,5	18	16 - 28	46	58 - 71	10
ESKV-L 50	10066396	10066522	10066506	M 50x1,5	18	21 - 35	55	63 - 76	10
ESKV-L 63	10066397	10066523	10066507	M 63x1,5	18	34 - 48	68	67 - 81	10

Accesórios Recomendados



EMUG

RDE

EADR

BS

MFD

Prensa Cabo SPRINT® LowTemp, ESKV LT, métrico, EN 62444



ESKV LT



ESKV-L LT

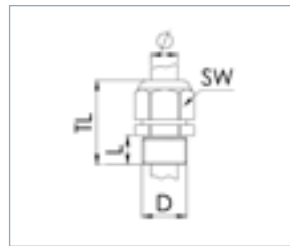

Classe de proteção IP68 (5 bar 30 min) / IP69
Teste de fio incandescente 750 °C
Faixa de temperatura -60 °C - 100 °C
Material Prensa Cabo de Poliamida, Vedação de Silicone

ESKV LT

Type	WISKA-No. RAL 7035	WISKA-No. RAL 7001	WISKA-No. RAL 9005					TL (mm)	
ESKV 12 LT	10062763	10061917	10061490	M 12x1,5	9	3 - 7	16	29 - 34	50
ESKV 16 LT	10062777	10061957	10061499	M 16x1,5	9	4,5 - 10	20	31 - 37	50
ESKV 20 LT	10062778	10061121	10061509	M 20x1,5	10	6 - 13	24	36 - 45	50
ESKV 25 LT	10062779	10061463	10061518	M 25x1,5	10	9 - 17	29	38 - 47	50
ESKV 32 LT	10062780	10061491	10061799	M 32x1,5	12	13 - 21	36	42 - 51	25
ESKV 40 LT	10062781	10061500	10061853	M 40x1,5	12	16 - 28	46	52 - 65	10
ESKV 50 LT	10062782	10061510	10061866	M 50x1,5	14	21 - 35	55	59 - 72	4
ESKV 63 LT	10062800	10061644	10061911	M 63x1,5	15	34 - 48	68	64 - 78	3

ESKV-L LT, longo

Type	WISKA-No. RAL 7035	WISKA-No. RAL 7001	WISKA-No. RAL 9005					TL (mm)	
ESKV-L 12 LT	10062737	10061512	10061690	M 12x1,5	15	3 - 7	16	35 - 40	50
ESKV-L 16 LT	10062738	10061691	10061855	M 16x1,5	15	4,5 - 10	20	37 - 43	50
ESKV-L 20 LT	10062739	10061860	10061868	M 20x1,5	15	6 - 13	24	41 - 50	50
ESKV-L 25 LT	10062758	10061869	10061907	M 25x1,5	15	9 - 17	29	43 - 52	50
ESKV-L 32 LT	10062759	10061908	10061919	M 32x1,5	15	13 - 21	36	45 - 54	25
ESKV-L 40 LT	10062760	10061951	10061950	M 40x1,5	18	16 - 28	46	58 - 71	10
ESKV-L 50 LT	10062761	10061494	10061493	M 50x1,5	18	21 - 35	55	63 - 76	10
ESKV-L 63 LT	10062762	10061504	10061502	M 63x1,5	18	34 - 48	68	67 - 81	10

Acessórios Recomendados



RDE LT

BS

EADR LT

PLÁSTICO
METAL
MARÍTIMO
EMC
EX E/I
EX D
FERROVIÁRIO
EQUILIBRAÇÃO / VENTILAÇÃO
PADRÃO BRITÂNICO
VEDAÇÕES
MEMBRANA
CONMAXX
CONMAXX GLAND
BRACE FITTING PLÁSTICO
BRACE CONDUIT PLÁSTICO
BRACE FITTING METAL
BRACE CONDUIT METAL

Pressa Cabo SPRINT® com acessórios, ESKV, métrico, EN 62444



ESKV-SET





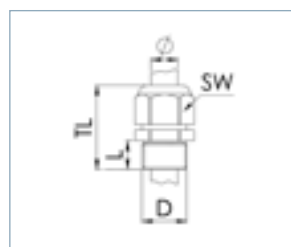

ESKV-RDE LT







Classe de proteção IP68 (5 bar 30 min) / IP69
Teste de fio incandescente 750 °C
Faixa de temperatura -40 °C - 100 °C
Material Pressa Cabo de Poliamida, Vedação de EPDM

ESKV-SET, com contra porca

Type	WISKA-No. RAL 7035	 D (mm)	 (mm)	 (mm)	 SW (mm)	TL (mm)	
ESKV-SET 12	10066524	M 12x1,5	9	3 · 7	16	29 · 34	50
ESKV-SET 16	10066525	M 16x1,5	9	4,5 · 10	20	31 · 37	50
ESKV-SET 20	10066526	M 20x1,5	10	6 · 13	24	36 · 45	50
ESKV-SET 25	10066527	M 25x1,5	10	9 · 17	29	38 · 47	50
ESKV-SET 32	10066528	M 32x1,5	12	13 · 21	36	42 · 51	25
ESKV-SET 40	10066529	M 40x1,5	12	16 · 28	46	52 · 65	10
ESKV-SET 50	10066530	M 50x1,5	14	21 · 35	55	59 · 72	4
ESKV-SET 63	10066531	M 63x1,5	15	34 · 48	68	64 · 78	3

ESKV-RDE LT, com inserto de vedação de redução

Type	WISKA-No. RAL 7035	WISKA-No. RAL 7001	WISKA-No. RAL 9005	 D (mm)	 (mm)	 (mm)	 SW (mm)	TL (mm)	
ESKV-RDE LT 12	10064976	10064984	10064992	M 12x1,5	9	1 · 7	16	29 · 34	50
ESKV-RDE LT 16	10064977	10064985	10064993	M 16x1,5	9	2 · 10	20	31 · 37	50
ESKV-RDE LT 20	10064978	10064986	10064994	M 20x1,5	10	4 · 13	24	36 · 45	50
ESKV-RDE LT 25	10064979	10064987	10064995	M 25x1,5	10	7 · 17	29	38 · 47	50
ESKV-RDE LT 32	10064980	10064988	10064996	M 32x1,5	12	9 · 21	36	42 · 51	25
ESKV-RDE LT 40	10064981	10064989	10064997	M 40x1,5	12	12 · 28	46	52 · 65	10
ESKV-RDE LT 50	10064982	10064990	10064998	M 50x1,5	14	16 · 35	55	59 · 72	4
ESKV-RDE LT 63	10064983	10064991	10064999	M 63x1,5	15	28 · 48	68	64 · 78	3

Acessórios Recomendados



Vedação Prensa Cabo SPRINT® retardadoras de chamas, ESKV-F, métricas, EN 62444



ESKV-F

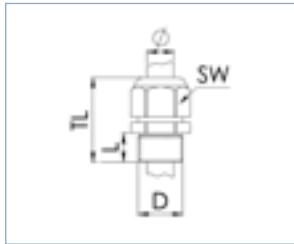

Classe de proteção IP68 (5 bar 30 min) / IP69
Teste de fio incandescente 960 °C
Faixa de temperatura -40 °C - 100 °C
Material Prensa Cabo de Poliamida, retardador de chama, Vedação de EPDM

Type	WISKA-No. RAL 7035						
ESKV-F 12	10064626	M 12x1,5	9	3 · 7	16	29 · 34	50
ESKV-F 16	10064627	M 16x1,5	9	4,5 · 10	20	31 · 37	50
ESKV-F 20	10064628	M 20x1,5	10	6 · 13	24	36 · 45	50
ESKV-F 25	10064629	M 25x1,5	10	9 · 17	29	38 · 47	50
ESKV-F 32	10064630	M 32x1,5	12	13 · 21	36	42 · 51	25
ESKV-F 40	10064631	M 40x1,5	12	16 · 28	46	52 · 65	10
ESKV-F 50	10064632	M 50x1,5	14	21 · 35	55	59 · 72	4
ESKV-F 63	10064633	M 63x1,5	15	34 · 48	68	64 · 78	3

Accessórios Recomendados

EMUF RDE EADR BS MFD

- PLÁSTICO
- METAL
- MARITIM
- EMC
- EX E/I
- EX D
- FERROVIÁRIO
- EQUALIZAÇ / VENTILAÇÃO
- PADRÃO BRITÂNICO
- VEDAÇÕES
- MEMBRANA
- CONMAXX
- CONMAXX GLAND
- BRACE FITTING PLÁSTICO
- BRACE CONDUIT PLÁSTICO
- BRACE FITTING METAL
- BRACE CONDUIT METAL

Pressa Cabo com alívio de tensão, SKV, PG

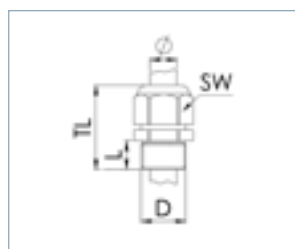

SKV



Classe de proteção IP68 (5 bar 30 min)
Teste de fio incandescente 750 °C
Faixa de temperatura -40 °C - 100 °C
Material Pressa Cabo de Poliamida, Vedação de EPDM

Type	WISKA-No. RAL 7035	WISKA-No. RAL 7001	WISKA-No. RAL 9005	D (mm)	TL (mm)	SW (mm)	TL (mm)		
SKV 7	10066400	10066001	10066191	PG 7	9	3 - 6	15	28 - 32	50
SKV 9	10066401	10066002	10066192	PG 9	9	4 - 8	19	32 - 36	50
SKV 11	10066402	10066003	10066193	PG 11	9	5 - 10	22	33 - 39	50
SKV 13,5	10066403	10066004	10066194	PG 13,5	10	6 - 12	24	35 - 41	50
SKV 16	10066404	10066005	10066195	PG 16	11	8 - 14	27	38 - 44	50
SKV 21	10066405	10066006	10066196	PG 21	11	10 - 18	33	43 - 50	25
SKV 29	10066406	10066007	10066197	PG 29	12	16 - 25	42	47 - 56	20
SKV 36	10066407	10066008	10066198	PG 36	14	22 - 32	53	56 - 65	10
SKV 42	10066408	10066009	10066199	PG 42	14	28 - 38	60	58 - 67	5
SKV 48	10066409	10101793	10066200	PG 48	15	36 - 44	65	60 - 68	4

Acessórios Recomendados



MUG

ADR

BS

Conexões de cabo SPRINT®, NSKV, NPT



NSKV

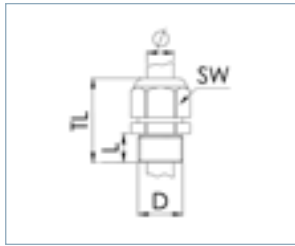

Classe de proteção IP68 (5 bar 30 min) / IP69
Teste de fio incandescente 750 °C
Faixa de temperatura -40 °C - 100 °C
Material Pressa Cabo de Poliamida, Vedação de EPDM

Type	WISKA-No. RAL 7035	WISKA-No. RAL 9005					TL (mm)	
NSKV 1/4	10062655	10061854	NPT 1/4"	15	3 - 7	16	33 - 38	50
NSKV 3/8	10062656	10061867	NPT 3/8"	15	4,5 - 10	20	35 - 41	50
NSKV 1/2	10062657	10061906	NPT 1/2"	15	6 - 13	24	42 - 51	50
NSKV 3/4	10062658	10061918	NPT 3/4"	15	9 - 17	29	44 - 53	50
NSKV 1	10062659	10061041	NPT 1"	15	13 - 21	36	50 - 59	25
NSKV 1 1/4	10062731	10061492	NPT 1 1/4"	18	16 - 28	46	60 - 73	10
NSKV 1 1/2	10062732	10061501	NPT 1 1/2"	18	21 - 35	55	65 - 78	4
NSKV 2	10062736	10061511	NPT 2"	18	34 - 48	68	69 - 83	3



- PLÁSTICO
- METAL
- MARÍTIMO
- EMC
- EX E/I
- EX D
- FERROVIÁRIO
- EQUALIZAÇÃO / VENTILAÇÃO
- PADRÃO BRITÂNICO
- VEDAÇÕES
- MEMBRANA
- CONMAXX
- CONMAXX GLAND
- BRACE FITTING PLÁSTICO
- BRACE CONDUIT PLÁSTICO
- BRACE FITTING METAL
- BRACE CONDUIT METAL

Pressa Cabo SPRINT® com proteção contra dobras



ESKVS



ESKVS-L



SKVS

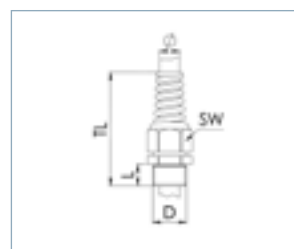

Classe de proteção IP68 (5 bar 30 min) / IP69
Teste de fio incandescente 750 °C
Faixa de temperatura -40 °C - 100 °C
Material Pressa Cabo de Poliamida, Vedação de EPDM

ESKVS, métrico, EN 62444

Type	WISKA-No. RAL 7035	WISKA-No. RAL 9005					TL (mm)	
ESKVS 12	10060757	10061276	M 12x1,5	9	3 - 7	16	72 - 77	100
ESKVS 16	10060758	10061277	M 16x1,5	9	4,5 - 10	20	82 - 88	100
ESKVS 20	10060759	10061278	M 20x1,5	10	6 - 13	24	103 - 112	50
ESKVS 25	10060760	10061279	M 25x1,5	10	9 - 17	29	119 - 128	25
ESKVS 32	10060761	10061283	M 32x1,5	12	13 - 21	36	138 - 147	10

ESKVS-L, métrico, longo, EN 62444

Type	WISKA-No. RAL 7035	WISKA-No. RAL 9005					TL (mm)	
ESKVS-L 12	10061210	10061215	M 12x1,5	15	3 - 7	16	78 - 83	100
ESKVS-L 16	10061211	10061216	M 16x1,5	15	4,5 - 10	20	88 - 94	100
ESKVS-L 20	10061212	10061217	M 20x1,5	15	6 - 13	24	108 - 117	50
ESKVS-L 25	10061213	10061219	M 25x1,5	15	9 - 17	29	124 - 133	25
ESKVS-L 32	10061214	10061220	M 32x1,5	15	13 - 21	36	141 - 150	10

SKVS, alívio de tensão, PG

Type	WISKA-No. RAL 7035	WISKA-No. RAL 9005					TL (mm)	
SKVS 7	10060615	10061871	PG 7	8	3 - 6,5	15	68	100
SKVS 9	10060616	10061872	PG 9	8	4 - 8	19	80	100
SKVS 11	10060617	10061873	PG 11	8	5 - 10	22	92	50
SKVS 13,5	10060618	10061874	PG 13,5	9	6 - 12	24	105	25
SKVS 16	10060619	10061875	PG 16	10	10 - 14	27	119	25
SKVS 21	10060620	10061876	PG 21	11	13 - 18	33	139	10

Acessórios Recomendados



Prensa Cabo SPRINT® com alívio de tensão externo, ESKVZ, métrico, EN 62444



ESKVZ



ESKVZ-L

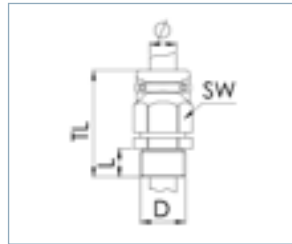

Classe de proteção IP68 (5 bar 30 min) / IP69
Teste de fio incandescente 750 °C
Faixa de temperatura -40 °C · 100 °C
Material Prensa Cabo de Poliamida, Vedação de EPDM

ESKVZ

Type	WISKA-No. RAL 7035	WISKA-No. RAL 9005					TL (mm)	
ESKVZ 12	10060722	10061475	M 12x1,5	9	3 · 7	16	38 · 43	100
ESKVZ 16	10060723	10061476	M 16x1,5	9	4,5 · 10	20	40 · 46	100
ESKVZ 20	10060724	10061477	M 20x1,5	10	6 · 13	24	49 · 58	50
ESKVZ 25	10060725	10061478	M 25x1,5	10	9 · 17	29	51 · 60	25
ESKVZ 32	10060727	10061479	M 32x1,5	12	13 · 21	36	57 · 66	10

ESKVZ-L, longo

Type	WISKA-No. RAL 7035	WISKA-No. RAL 9005					TL (mm)	
ESKVZ-L 12	10061465	10061470	M 12x1,5	15	3 · 7	16	44 · 49	100
ESKVZ-L 16	10061466	10061471	M 16x1,5	15	4,5 · 10	20	46 · 52	100
ESKVZ-L 20	10061467	10061472	M 20x1,5	15	6 · 13	24	54 · 63	50
ESKVZ-L 25	10061468	10061473	M 25x1,5	15	9 · 17	29	56 · 65	25
ESKVZ-L 32	10061469	10061474	M 32x1,5	15	13 · 21	36	60 · 69	10

Accessórios Recomendados

EMUG RDE EADR BS

PLÁSTICO
 METAL
 MARÍTIMO
 EMC
 EX E/I
 EX D
 FERROVIÁRIO
 EQUALIZAÇÃO / VENTILAÇÃO
 PADRÃO BRITÂNICO
 VEDAÇÕES
 MEMBRANA
 CONMAXX
 CONMAXX GLAND
 BRACE FITTING PLÁSTICO
 BRACE CONDUIT PLÁSTICO
 BRACE FITTING METAL
 BRACE CONDUIT METAL

SPRINT® Porcas de Fixação



EMUG



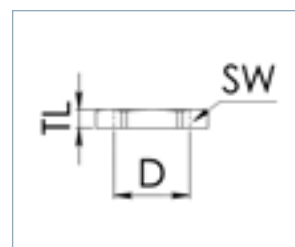

MUG





Faixa de temperatura
Material

-40 °C - 100 °C
Poliamida, reforçada com fibra

EMUG, métrica

Type	WISKA-No. RAL 7035	WISKA-No. RAL 7001	WISKA-No. RAL 9005			TL (mm)	
EMUG 12	10060770	10062712	10061780	M 12x1,5	18	5	100
EMUG 16	10060771	10062713	10061781	M 16x1,5	22	5	100
EMUG 20	10060772	10062714	10061782	M 20x1,5	27	5	100
EMUG 25	10060773	10062715	10061783	M 25x1,5	32	6	100
EMUG 32	10060774	10062716	10061784	M 32x1,5	40	6	100
EMUG 40	10060775	10062717	10061785	M 40x1,5	50	7	50
EMUG 50	10060776	10062718	10061786	M 50x1,5	60	7	25
EMUG 63	10060777	10062719	10061787	M 63x1,5	75	7	10

MUG, PG

Type	WISKA-No. RAL 7035	WISKA-No. RAL 9005			TL (mm)	
MUG 7	10060670	10060680	PG 7	19	5	100
MUG 9	10060671	10060681	PG 9	22	5	100
MUG 11	10060672	10060682	PG 11	24	5	100
MUG 13,5	10060673	10060683	PG 13,5	27	6	100
MUG 16	10060674	10060684	PG 16	30	6	100
MUG 21	10060675	10060685	PG 21	36	7	100
MUG 29	10060676	10060686	PG 29	46	7	50
MUG 36	10060677	10060687	PG 36	60	8	25
MUG 42	10060678	10060688	PG 42	65	8	25
MUG 48	10060679	10060689	PG 48	70	8	10

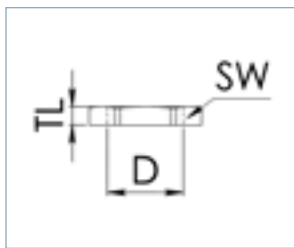

SPRINT® Porcas de fixação retardadoras de chama, EMUF, métricas



EMUF



Teste de fio incandescente 960 °C
Faixa de temperatura -40 °C - 100 °C
Material Poliamida UL94-V0

Type	WISKA-No. RAL 7035	WISKA-No. RAL 9005			TL (mm)	
EMUF 12	10060810	10061770	M 12x1,5	18	5	100
EMUF 16	10060811	10061771	M 16x1,5	22	5	100
EMUF 20	10060812	10061772	M 20x1,5	27	5	100
EMUF 25	10060813	10061773	M 25x1,5	32	6	100
EMUF 32	10060814	10061774	M 32x1,5	40	6	100
EMUF 40	10060815	10061775	M 40x1,5	50	7	50
EMUF 50	10060816	10061776	M 50x1,5	60	7	25
EMUF 63	10060817	10061777	M 63x1,5	75	7	10

Bujão



EVSG



VSG

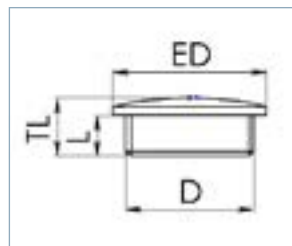

Classe de proteção
Faixa de temperatura

IP56
-40 °C - 100 °C
com vedação IP66 / IP68
Poliamida, reforçada com fibra

w

Material

EVSG, métrica

Type	WISKA-No. RAL 7035	WISKA-No. RAL 7001	WISKA-No. RAL 9005			ED (mm)	TL (mm)	
EVSG 12	10060624	10062514	10061830	M 12x1,5	6	15	8	100
EVSG 16	10060625	10062515	10061831	M 16x1,5	6	20	9	100
EVSG 20	10060626	10062516	10061832	M 20x1,5	6	24	9,5	100
EVSG 25	10060627	10062517	10061833	M 25x1,5	8	30	11,5	100
EVSG 32	10060628	10062518	10061834	M 32x1,5	8	37	12	100
EVSG 40	10060629	10062519	10061835	M 40x1,5	8	46	13	50
EVSG 50	10060630	10062520	10061836	M 50x1,5	10	56	15	50
EVSG 63	10060631	10062521	10061837	M 63x1,5	12	70	17	25

VSG, PG

Type	WISKA-No. RAL 7035			ED (mm)	TL (mm)	
VSG 7	50060728	PG 7	6	15	8	100
VSG 9	50060729	PG 9	6	19	9	100
VSG 11	50060730	PG 11	6	22	9	100
VSG 13,5	50060731	PG 13,5	6	25	9,5	100
VSG 16	10060732	PG 16	6	27	9,5	100
VSG 21	50060733	PG 21	8	33	11	100
VSG 29	50060734	PG 29	8	44	12	100
VSG 36	50060735	PG 36	10	55	15	25
VSG 42	50060736	PG 42	10	62	16	25
VSG 48	50060737	PG 48	12	70	16	25

Acessórios Recomendados



EMUG/MUG

EADR/ADR

Adaptadores de ampliação



KEM



KEP

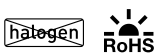
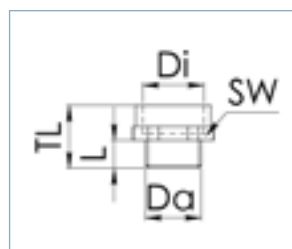

Faixa de temperatura
Material

-40 °C - 100 °C
Poliamida, reforçada com fibra

KEM, métrico-métrico

Type	WISKA-No. RAL 7035	Da (mm)	Di (mm)	L (mm)	SW (mm)	TL (mm)	
KEM 12/16	10063570	M 12x1,5	M 16x1,5	9	20	27	100
KEM 16/20	10063571	M 16x1,5	M 20x1,5	9	24	27	100
KEM 20/25	10063572	M 20x1,5	M 25x1,5	9	29	27	100
KEM 25/32	10063573	M 25x1,5	M 32x1,5	10	36	28	100
KEM 32/40	10063574	M 32x1,5	M 40x1,5	12	46	30	50
KEM 40/50	10063575	M 40x1,5	M 50x1,5	12	55	30	25
KEM 50/63	10063576	M 50x1,5	M 63x1,5	14	68	32	5

KEP, PG-PG

Type	WISKA-No. RAL 7035	Da (mm)	Di (mm)	L (mm)	SW (mm)	TL (mm)	
KEP 7/9	10063595	PG 7	PG 9	9	20	27	100
KEP 9/11	10063596	PG 9	PG 11	9	22	27	100
KEP 11/13,5	10063597	PG 11	PG 13,5	9	24	27	100
KEP 13,5/16	10063598	PG 13,5	PG 16	10	27	28	100
KEP 16/21	10063599	PG 16	PG 21	10	33	28	50
KEP 21/29	10063600	PG 21	PG 29	12	42	30	25
KEP 29/36	10063601	PG 29	PG 36	12	53	30	20
KEP 36/42	10063602	PG 36	PG 42	14	60	32	10
KEP 42/48	10063603	PG 42	PG 48	14	65	32	5

Acessórios Recomendados



EMUG/MUG

EADR/ADR

Adaptadores de redução, KRM, métrico-métrico

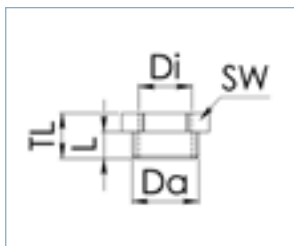

KRM



Faixa de temperatura
Material

-40 °C - 100 °C
Poliamida, reforçada com fibra

Type	WISKA-No. RAL 7035	Da (mm)	Di (mm)	TL (mm)	SW (mm)	TL (mm)	
KRM 16/12	10063577	M 16x1,5	M 12x1,5	9	22	16	100
KRM 20/12	10063578	M 20x1,5	M 12x1,5	9	24	16	100
KRM 20/16	10063579	M 20x1,5	M 16x1,5	9	24	27	100
KRM 25/12	10063580	M 25x1,5	M 12x1,5	10	29	17	100
KRM 25/16	10063581	M 25x1,5	M 16x1,5	10	29	17	100
KRM 25/20	10063582	M 25x1,5	M 20x1,5	10	29	17	100
KRM 32/16	10063583	M 32x1,5	M 16x1,5	12	36	19	50
KRM 32/20	10063584	M 32x1,5	M 20x1,5	12	36	19	50
KRM 32/25	10063585	M 32x1,5	M 25x1,5	12	36	19	50
KRM 40/20	10063586	M 40x1,5	M 20x1,5	12	46	19	25
KRM 40/25	10063587	M 40x1,5	M 25x1,5	12	46	19	25
KRM 40/32	10063588	M 40x1,5	M 32x1,5	12	46	19	25
KRM 50/25	10063589	M 50x1,5	M 25x1,5	14	55	21	5
KRM 50/32	10063590	M 50x1,5	M 32x1,5	14	55	21	5
KRM 50/40	10063591	M 50x1,5	M 40x1,5	14	55	21	5
KRM 63/32	10063592	M 63x1,5	M 32x1,5	15	65	22	5
KRM 63/40	10063593	M 63x1,5	M 40x1,5	15	65	22	5
KRM 63/50	10063594	M 63x1,5	M 50x1,5	15	65	22	5

Acessórios Recomendados



EMUG

EADR

Adaptadores de redução, KRP, PG-PG



KRP Form A



KRP Form B

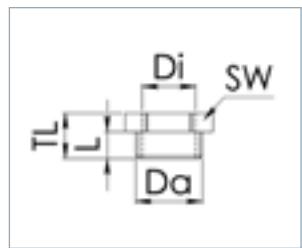
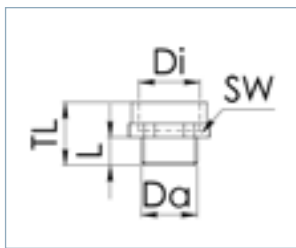

Faixa de temperatura -40 °C - 100 °C
Material Poliamida, reforçada com fibra

Type	WISKA-No. RAL 7035	Da (mm)	Di (mm)	TL (mm)	SW (mm)	TL (mm)	Form	Quantidade
KRP 9/7	10063604	PG 9	PG 7	9	20	27	A	100
KRP 11/7	10063605	PG 11	PG 7	9	22	16	B	100
KRP 11/9	10063606	PG 11	PG 9	9	22	27	A	100
KRP 13,5/7	10063607	PG 13,5	PG 7	10	24	17	B	100
KRP 13,5/9	10063608	PG 13,5	PG 9	10	24	28	A	100
KRP 13,5/11	10063609	PG 13,5	PG 11	10	24	28	A	100
KRP 16/9	10063610	PG 16	PG 9	10	27	17	B	100
KRP 16/11	10063611	PG 16	PG 11	10	27	28	A	100
KRP 16/13,5	10063612	PG 16	PG 13,5	10	27	28	A	100
KRP 21/11	10063613	PG 21	PG 11	12	33	19	B	100
KRP 21/13,5	10063614	PG 21	PG 13,5	12	33	19	B	100
KRP 21/16	10063615	PG 21	PG 16	12	33	19	B	100
KRP 29/13,5	10063616	PG 29	PG 13,5	12	42	19	B	50
KRP 29/16	10063617	PG 29	PG 16	12	42	19	B	50
KRP 29/21	10063618	PG 29	PG 21	12	42	19	B	50
KRP 36/16	10063619	PG 36	PG 16	14	53	21	B	50
KRP 36/21	10063620	PG 36	PG 21	14	53	21	B	50
KRP 36/29	10063621	PG 36	PG 29	14	53	21	B	10
KRP 42/21	10063622	PG 42	PG 21	14	60	21	B	10
KRP 42/29	10063623	PG 42	PG 29	14	60	21	B	10
KRP 42/36	10063624	PG 42	PG 36	14	60	21	B	10
KRP 48/29	10063625	PG 48	PG 29	15	65	22	B	10
KRP 48/36	10063626	PG 48	PG 36	15	65	22	B	10
KRP 48/42	10063627	PG 48	PG 42	15	65	22	B	10



Cotovelos 90 °, EWI90, métrico

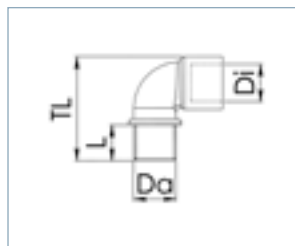

EWI 90



Faixa de temperatura
Material

-40 °C - 100 °C
Poliamida

Type	WISKA-No. RAL 7035	WISKA-No. RAL 7001	WISKA-No. RAL 9005	D (mm)	L (mm)	TL (mm)	
EWI90 12	10064682	10064692	10064687	M 12x1,5	10	35	50
EWI90 16	10064683	10064693	10064688	M 16x1,5	8	36	50
EWI90 20	10064684	10064694	10064689	M 20x1,5	10,5	42,5	50
EWI90 25	10064685	10064695	10064690	M 25x1,5	15	54	50
EWI90 32	10064686	10064696	10064691	M 32x1,5	14	62	25

Acessórios Recomendados



EMUG

EADR



Prensa Cabos de Metal

Latão, aço inoxidável ou zinco - nossas conexões metálicas são usadas onde quer que condições difíceis prevaleçam. Na construção naval e offshore, máquinas e nas plantas de engenharia, automação e design higiênico. Projetos diferentes, segmentos de todos os tipos, conceitos de vedações e classes de proteção somadas uma extensa gama de ranges, garantindo que tenhamos uma boa solução para sua aplicação.

Prensa Cabo SPRINT®, EMSKV, métrico, EN 62444



EMSKV



EMSKV-L

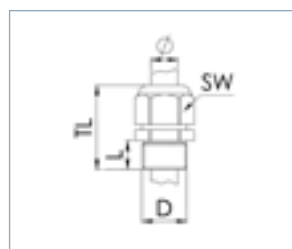

Classe de proteção
Faixa de temperatura
Material

IP68 (5 bar 30 min) / IP69

-40 °C - 100 °C

Prensa Cabo de Latão niquelado, Inserção de fixação Poliamida, Vedação de EPDM

EMSKV

Type	WISKA-No. Niquelado					TL (mm)	
EMSKV 12	10065000	M 12x1,5	5	3 · 7	16	23 · 30	50
EMSKV 16	10065001	M 16x1,5	5	4,5 · 10	20	26 · 34	50
EMSKV 20	10065002	M 20x1,5	6	6 · 13	24	29 · 37	50
EMSKV 25	10065003	M 25x1,5	7	9 · 17	29	33 · 42	50
EMSKV 32	10065004	M 32x1,5	8	13 · 21	36	36 · 44	25
EMSKV 40	10065005	M 40x1,5	8	16 · 28	46	44 · 55	10
EMSKV 50	10065006	M 50x1,5	9	21 · 35	55	51 · 62	10
EMSKV 63	10065007	M 63x1,5	10	34 · 48	68	56 · 67	10
EMSKV 75	10100865	M 75x1,5	12	48 · 62	82	67 · 81	1

EMSKV-L, longo

Type	WISKA-No. Niquelado					TL (mm)	
EMSKV-L 12	10065008	M 12x1,5	12	3 · 7	16	30 · 37	50
EMSKV-L 16	10065009	M 16x1,5	12	4,5 · 10	20	33 · 41	50
EMSKV-L 20	10065010	M 20x1,5	12	6 · 13	24	35 · 43	50
EMSKV-L 25	10065011	M 25x1,5	12	9 · 17	29	38 · 47	50
EMSKV-L 32	10065012	M 32x1,5	15	13 · 21	36	43 · 51	25
EMSKV-L 40	10065013	M 40x1,5	15	16 · 28	46	51 · 62	10
EMSKV-L 50	10065014	M 50x1,5	15	21 · 35	55	57 · 68	10
EMSKV-L 63	10065015	M 63x1,5	15	34 · 48	68	61 · 72	10

Acessórios Recomendados



RDE

EMMU

BS

MFD

Prensa Cabo SPRINT® LowTemp, EMSKV LT, métrico, EN 62444



EMSKV LT



EMSKV-L LT

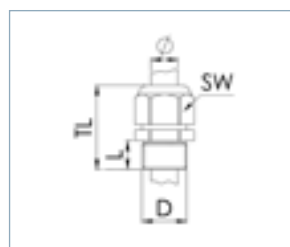

Classe de proteção
Faixa de temperatura
Material

IP68 (5 bar 30 min) / IP69

-60 °C - 100 °C

Prensa Cabo de Latão niquelado, Inserção de fixação Poliamida, Vedação de Silicone

EMSKV LT

Type	WISKA-No. Niquelado	D (mm)	L (mm)	Ø (mm)	SW (mm)	TL (mm)	Box
EMSKV 12 LT	10065800	M 12x1,5	5	3 - 7	16	23 - 30	50
EMSKV 16 LT	10065801	M 16x1,5	5	4,5 - 10	20	26 - 34	50
EMSKV 20 LT	10065802	M 20x1,5	6	6 - 13	24	29 - 37	50
EMSKV 25 LT	10065803	M 25x1,5	7	9 - 17	29	33 - 42	50
EMSKV 32 LT	10065804	M 32x1,5	8	13 - 21	36	36 - 44	25
EMSKV 40 LT	10065805	M 40x1,5	8	16 - 28	46	44 - 55	10
EMSKV 50 LT	10065806	M 50x1,5	9	21 - 35	55	51 - 62	10
EMSKV 63 LT	10065807	M 63x1,5	10	34 - 48	68	56 - 67	10

EMSKV-L LT, longo

Type	WISKA-No. Niquelado	D (mm)	L (mm)	Ø (mm)	SW (mm)	TL (mm)	Box
EMSKV-L 12 LT	10065808	M 12x1,5	12	3 - 7	16	30 - 37	50
EMSKV-L 16 LT	10065809	M 16x1,5	12	4,5 - 10	20	33 - 41	50
EMSKV-L 20 LT	10065810	M 20x1,5	12	6 - 13	24	35 - 43	50
EMSKV-L 25 LT	10065811	M 25x1,5	12	9 - 17	29	38 - 47	50
EMSKV-L 32 LT	10065812	M 32x1,5	15	13 - 21	36	43 - 51	25
EMSKV-L 40 LT	10065813	M 40x1,5	15	16 - 28	46	51 - 62	10
EMSKV-L 50 LT	10065814	M 50x1,5	15	21 - 35	55	57 - 68	10
EMSKV-L 63 LT	10065815	M 63x1,5	15	34 - 48	68	61 - 72	10

Acessórios Recomendados



EMMU

RDE LT

BS

Prensa Cabo SPRINT® com contra porca, EMSKV-SET, métrico, EN 62444

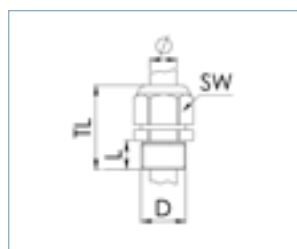

EMSKV-SET



Classe de proteção
Faixa de temperatura
Material

IP68 (5 bar 30 min) / IP69

-40 °C - 100 °C

Prensa Cabo de Latão niquelado, Inserção de fixação Poliamida, Vedação de EPDM

Type	WISKA-No. Niquelado	D (mm)	L (mm)	(mm)	SW (mm)	TL (mm)	(mm)
EMSKV-SET 12	10065032	M 12x1,5	5	3 - 7	16	23 - 30	50
EMSKV-SET 16	10065033	M 16x1,5	5	4,5 - 10	20	26 - 34	50
EMSKV-SET 20	10065034	M 20x1,5	6	6 - 13	24	29 - 37	50
EMSKV-SET 25	10065035	M 25x1,5	7	9 - 17	29	33 - 42	50
EMSKV-SET 32	10065036	M 32x1,5	8	13 - 21	36	36 - 44	25
EMSKV-SET 40	10065037	M 40x1,5	8	16 - 28	46	44 - 55	10
EMSKV-SET 50	10065038	M 50x1,5	9	21 - 35	55	51 - 62	10
EMSKV-SET 63	10065039	M 63x1,5	10	34 - 48	68	56 - 67	10

Accessórios Recomendados



RDE

BS

MFD

Prensa Cabo, MSKV, PG



MSKV

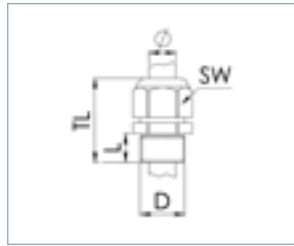





Classe de proteção
Faixa de temperatura
Material

IP68 (5 bar 30 min) / IP69

-40 °C - 100 °C

Prensa Cabo de Latão niquelado, Inserção de fixação Poliamida, Vedação de TPV

Type	WISKA-No. Niquelado	 D (mm)	 L (mm)	 (mm)	 SW (mm)	TL (mm)	
MSKV 7	10062281	PG 7	6	3 - 6,5	14	20 - 24	50
MSKV 9	10062282	PG 9	6	4 - 8	17	21 - 25	50
MSKV 11	10062283	PG 11	6	5 - 10	20	22 - 27	50
MSKV 13,5	10062284	PG 13,5	6,5	6 - 12	22	23,5 - 29,5	50
MSKV 16	10062285	PG 16	6,5	10 - 14	24	26 - 30	50
MSKV 21	10062286	PG 21	7	13 - 18	30	29 - 34	50
MSKV 29	10062287	PG 29	8	18 - 25	40	34,5 - 41,5	25
MSKV 36	10062288	PG 36	10	22 - 32	50	38 - 48	10
MSKV 42	10062289	PG 42	12	30 - 38	57	43 - 51	10
MSKV 48	10062290	PG 48	14	34 - 44	64	43 - 53	10

Acessórios Recomendados



MMU

- PLÁSTICO
- METAL
- MARÍTIMO
- EMC
- EX E/I
- EX D
- FERROVIÁRIO
- EQUALIZAÇÃO / VENTILAÇÃO
- PARDAO BRITÁNICO
- VEDAÇÕES
- MEMBRANA
- CONMAXX
- CONMAXX GLAND
- BRACE FITTING PLÁSTICO
- BRACE CONDUIT PLÁSTICO
- BRACE FITTING METAL
- BRACE CONDUIT METAL

Prensa Cabo SPRINT®



PMSKV



NMSKV

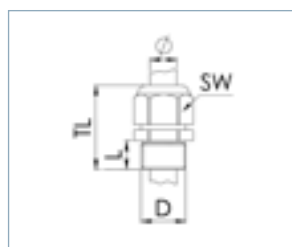





Classe de proteção
Faixa de temperatura
Material

IP68 (5 bar 30 min) / IP69





-40 °C - 100 °C

Prensa Cabo de Latão niquelado, Inserção de fixação Poliamida, Vedação de EPDM

PMSKV, PG

Type	WISKA-No. Niquelado	 D (mm)	 (mm)	 (mm)	 SW (mm)	TL (mm)	
PMSKV 7-12	10100677	PG 7	5	3 · 7	16	23 · 30	50
PMSKV 7-16	10100678	PG 7	5	4,5 · 10	20	26 · 34	50
PMSKV 9-16	10100490	PG 9	5	4,5 · 10	20	26 · 34	50
PMSKV 11-16	10100683	PG 11	6	4,5 · 10	22	27 · 35	50
PMSKV 11-20	10100684	PG 11	6	6 · 13	24	32 · 40	50
PMSKV 13,5-20	10100685	PG 13,5	6	6 · 13	24	28 · 36	50
PMSKV 13,5-25	10100491	PG 13,5	6	9 · 17	29	33 · 42	50
PMSKV 16-20	10100686	PG 16	6	6 · 13	29	28 · 36	50
PMSKV 16-25	10100687	PG 16	6	9 · 17	29	32 · 41	50
PMSKV 21-25	10100688	PG 21	7	9 · 17	36	33 · 42	50
PMSKV 21-32	10100689	PG 21	7	13 · 21	36	39 · 47	25
PMSKV 29-40	10100690	PG 29	8	16 · 28	46	44 · 55	10
PMSKV 36-50	10100691	PG 36	9	21 · 35	55	51 · 62	10
PMSKV 42-50	10100692	PG 42	10	21 · 35	60	52 · 63	10
PMSKV 48-63	10100693	PG 48	10	34 · 48	68	56 · 67	10

NMSKV, NPT

Type	WISKA-No. Niquelado	 D (mm)	 (mm)	 (mm)	 SW (mm)	TL (mm)	
NMSKV 1/4	10065480	NPT 1/4"	13	3 · 7	16	33 · 40	50
NMSKV 3/8	10065481	NPT 3/8"	13	4,5 · 10	20	35 · 42	50
NMSKV 1/2	10065482	NPT 1/2"	16	6 · 13	24	38 · 45	50
NMSKV 3/4	10065483	NPT 3/4"	16	9 · 17	29	40 · 48	50
NMSKV 1	10065484	NPT 1"	20	13 · 21	36	46 · 53	25
NMSKV 1 1/4	10065485	NPT 1 1/4"	20	16 · 28	46	50 · 58	10
NMSKV 1 1/2	10065486	NPT 1 1/2"	20	21 · 35	55	51 · 62	10
NMSKV 2	10065487	NPT 2"	21	34 · 48	68	56 · 67	10

Acessórios Recomendados



MMU

BS

MFD

Prensa Cabo SPRINT® com proteção flexível, EMSKVS, métrica, EN 62444



EMSKVS



EMSKVS-L

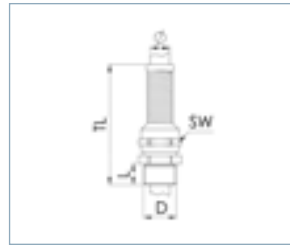

Classe de proteção
Faixa de temperatura
Material

IP68 (5 bar 30 min) / IP69

-40 °C - 100 °C

Prensa Cabo de Latão niquelado, Inserção de fixação Poliamida, Vedação de EPDM

EMSKVS

Type	WISKA-No. Niquelado	D (mm)	L (mm)	Ø (mm)	SW (mm)	TL (mm)	Box
EMSKVS 16	10065831	M 16x1,5	5	4,5 - 10	20	76 - 84	50
EMSKVS 20	10065832	M 20x1,5	6	6 - 13	24	96 - 104	50
EMSKVS 25	10065833	M 25x1,5	7	9 - 17	29	120 - 129	50
EMSKVS 32	10065834	M 32x1,5	8	13 - 21	36	146 - 154	25
EMSKVS 40	10065835	M 40x1,5	8	16 - 28	46	184 - 195	10
EMSKVS 50	10065836	M 50x1,5	9	21 - 35	55	231 - 242	10
EMSKVS 63	10065837	M 63x1,5	10	34 - 48	68	299 - 310	10

EMSKVS-L, longo

Type	WISKA-No. Niquelado	D (mm)	L (mm)	Ø (mm)	SW (mm)	TL (mm)	Box
EMSKVS-L 16	10065851	M 16x1,5	12	4,5 - 10	20	83 - 91	50
EMSKVS-L 20	10065852	M 20x1,5	12	6 - 13	24	102 - 110	50
EMSKVS-L 25	10065853	M 25x1,5	12	9 - 17	29	125 - 134	50
EMSKVS-L 32	10065854	M 32x1,5	15	13 - 21	36	153 - 161	25
EMSKVS-L 40	10065855	M 40x1,5	15	16 - 28	46	191 - 202	10
EMSKVS-L 50	10065856	M 50x1,5	15	21 - 35	55	237 - 248	10
EMSKVS-L 63	10065857	M 63x1,5	15	34 - 48	68	304 - 315	10

Acessórios Recomendados



RDE

EMMU

BS

MFD

Prensa Cabo SPRINT® com alívio de tensão externo, EMSKVZ, métrico, EN 62444



EMSKVZ



EMSKVZ-L

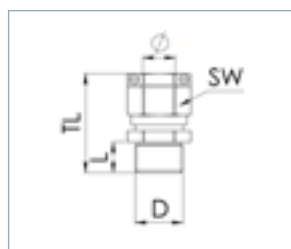

Classe de proteção
Faixa de temperatura
Material

IP68 (5 bar 30 min) / IP69

-40 °C - 100 °C

Prensa Cabo de Latão niquelado, Inserção de fixação Poliamida, Vedação de EPDM

EMSKVZ

Type	WISKA-No. Niquelado					TL (mm)	
EMSKVZ 16	10065351	M 16x1,5	5	4,5 - 10	20	34 - 42	25
EMSKVZ 20	10065352	M 20x1,5	6	6 - 13	24	37 - 45	25
EMSKVZ 25	10065353	M 25x1,5	7	9 - 17	29	42 - 51	25
EMSKVZ 32	10065354	M 32x1,5	8	13 - 21	36	45 - 54	10
EMSKVZ 40	10065355	M 40x1,5	8	16 - 28	46	54 - 65	5
EMSKVZ 50	10065356	M 50x1,5	9	21 - 35	55	53 - 77	5
EMSKVZ 63	10065357	M 63x1,5	10	34 - 48	68	73 - 84	5

EMSKVZ-L, longo

Type	WISKA-No. Niquelado					TL (mm)	
EMSKVZ-L 16	10065860	M 16x1,5	12	4,5 - 10	20	41 - 49	25
EMSKVZ-L 20	10065861	M 20x1,5	12	6 - 13	24	43 - 51	25
EMSKVZ-L 25	10065862	M 25x1,5	12	9 - 17	29	47 - 56	25
EMSKVZ-L 32	10065863	M 32x1,5	15	13 - 21	36	53 - 61	10
EMSKVZ-L 40	10065864	M 40x1,5	15	16 - 28	46	61 - 72	5
EMSKVZ-L 50	10065865	M 50x1,5	15	21 - 35	55	69 - 80	5
EMSKVZ-L 63	10065866	M 63x1,5	15	34 - 48	68	78 - 89	5

Acessórios Recomendados

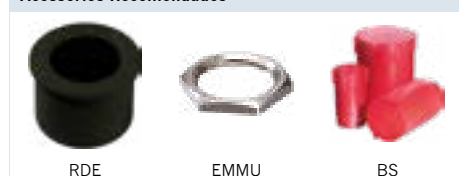

RDE

EMMU

BS

Prensa Cabo de compressão ShotGLAND, EMCGV, métrica, EN 62444





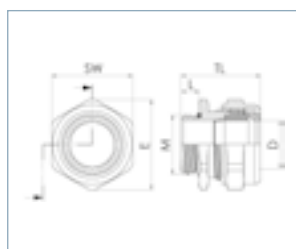

EMCGV







Classe de proteção
Faixa de temperatura
Material

IP68 (5 bar 30 min)
-40° C - 120 °C
Prensa Cabo de Latão niquelado, Vedação de EPDM

Type	WISKA-No.	 D (mm)	 L (mm)	 (mm)	 SW (mm)	TL (mm)	
EMCGV 8-030	10106389	M 8x1,25	5	2 - 3,3	11	15 - 18,5	50
EMCGV 8-040	10106390	M 8x1,25	5	3 - 4,3	11	15 - 18,5	50
EMCGV 8-050	10106391	M 8x1,25	5	4 - 5,3	11	15 - 18,5	50
EMCGV 12-030	10106392	M 12x1,5	6	2 - 3	18	20,5 - 24,5	50
EMCGV 12-050	10106393	M 12x1,5	6	3 - 5	18	20,5 - 24,5	50
EMCGV 12-070	10106394	M 12x1,5	6	5 - 7	18	20,5 - 24,5	50
EMCGV 12-090	10106395	M 12x1,5	6	7 - 9	18	20,5 - 24,5	50
EMCGV 16-040	10106396	M 16x1,5	6	2 - 4	22	22 - 26,5	50
EMCGV 16-060	10106397	M 16x1,5	6	4 - 6	22	22 - 26,5	50
EMCGV 16-080	10106398	M 16x1,5	6	6 - 8	22	22 - 26,5	50
EMCGV 16-100	10106399	M 16x1,5	6	8 - 10	22	22 - 26,5	50
EMCGV 16-120	10106400	M 16x1,5	6	10 - 12	22	22 - 26,5	50
EMCGV 20-060	10106401	M 20x1,5	6	4 - 6	27	22 - 26,5	50
EMCGV 20-080	10106402	M 20x1,5	6	6 - 8	27	22 - 26,5	50
EMCGV 20-100	10106403	M 20x1,5	6	8 - 10	27	22 - 26,5	50
EMCGV 20-120	10106404	M 20x1,5	6	10 - 12	27	22 - 26,5	50
EMCGV 20-140	10106405	M 20x1,5	6	12 - 14	27	22 - 26,5	50
EMCGV 20-160	10106406	M 20x1,5	6	14 - 16	27	22 - 26,5	50
EMCGV 25-080	10106407	M 25x1,5	7	6 - 8	30	23 - 28	50
EMCGV 25-100	10106408	M 25x1,5	7	8 - 10	30	23 - 28	50
EMCGV 25-120	10106409	M 25x1,5	7	10 - 12	30	23 - 28	50
EMCGV 25-140	10106410	M 25x1,5	7	12 - 14	30	23 - 28	50
EMCGV 25-160	10106411	M 25x1,5	7	14 - 16	30	23 - 28	50
EMCGV 25-170	10106412	M 25x1,5	7	15 - 17	30	23 - 28	50
EMCGV 32-110	10106413	M 32x1,5	8	9 - 11	36	24 - 28,5	25
EMCGV 32-130	10106414	M 32x1,5	8	11 - 13	36	24 - 28,5	25
EMCGV 32-150	10106415	M 32x1,5	8	13 - 15	36	24 - 28,5	25
EMCGV 32-180	10106416	M 32x1,5	8	16 - 18	36	24 - 28,5	25
EMCGV 32-200	10106417	M 32x1,5	8	18 - 20	36	24 - 28,5	25
EMCGV 32-230	10106419	M 32x1,5	8	21 - 23	36	24 - 28,5	25
EMCGV 40-180	10106420	M 40x1,5	8	16 - 18	45	24 - 28,5	10
EMCGV 40-200	10106421	M 40x1,5	8	18 - 20	45	24 - 28,5	10
EMCGV 40-220	10106422	M 40x1,5	8	20 - 22	45	24 - 28,5	10
EMCGV 40-240	10106423	M 40x1,5	8	22 - 24	45	24 - 28,5	10
EMCGV 40-260	10106424	M 40x1,5	8	24 - 26	45	24 - 28,5	10
EMCGV 40-290	10106425	M 40x1,5	8	26 - 29	45	24 - 28,5	10
EMCGV 50-280	10106426	M 50x1,5	9	26 - 28	55	25,5 - 30	10
EMCGV 50-300	10106427	M 50x1,5	9	28 - 30	55	25,5 - 30	10
EMCGV 50-320	10106428	M 50x1,5	9	30 - 32	55	25,5 - 30	10
EMCGV 50-340	10106429	M 50x1,5	9	32 - 34	55	25,5 - 30	10
EMCGV 50-360	10106430	M 50x1,5	9	34 - 36	55	25,5 - 30	10
EMCGV 50-380	10106431	M 50x1,5	9	36 - 38	55	25,5 - 30	10

PLÁSTICO
METAL
MARÍTIMO
EMC
EX E/I
EX D
FERROVIÁRIO
EQUILIBRAÇÃO / VENTILAÇÃO
PADRÃO BRITÂNICO
VEDAÇÕES
MEMBRANA
CONMAXX
CONMAXX GLAND
BRACE FITTING PLÁSTICO
BRACE CONDUIT PLÁSTICO
BRACE FITTING METAL
BRACE CONDUIT METAL

Type	WISKA-No.					TL (mm)	
EMCGV 63-350	10106432	M 63x1,5	10	33 · 35	68	26,5 · 31	10
EMCGV 63-380	10106433	M 63x1,5	10	35 · 38	68	26,5 · 31	10
EMCGV 63-410	10106434	M 63x1,5	10	38 · 41	68	26,5 · 31	10
EMCGV 63-440	10106435	M 63x1,5	10	41 · 44	68	26,5 · 31	10
EMCGV 63-470	10106436	M 63x1,5	10	44 · 47	68	26,5 · 31	10
EMCGV 63-490	10106437	M 63x1,5	10	47 · 49	68	26,5 · 31	10

Acessórios Recomendados



EMMU

Prensa Cabo de compressão ShotGland baixa Temperatura LowTemp, EMCGV LT, métrica





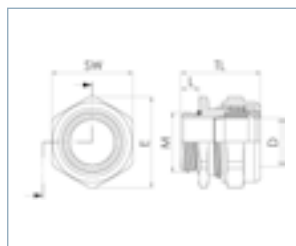







EMCGV LT



Classe de proteção
Faixa de temperatura
Material

IP68 (5 bar 30 min)
-60 °C · 180 °C
Prensa Cabo de Latão niquelado, Vedação de Silicone

Type	WISKA-No.					TL (mm)	
EMCGV 8-030 LT	10106492	M 8x1,25	5	2 · 3,3	11	15 · 18,5	50
EMCGV 8-040 LT	10106493	M 8x1,25	5	3 · 4,3	11	15 · 18,5	50
EMCGV 8-050 LT	10106494	M 8x1,25	5	4 · 5,3	11	15 · 18,5	50
EMCGV 12-030 LT	10106495	M 12x1,5	6	2 · 3	18	20,5 · 24,5	50
EMCGV 12-050 LT	10106496	M 12x1,5	6	3 · 5	18	20,5 · 24,5	50
EMCGV 12-070 LT	10106497	M 12x1,5	6	5 · 7	18	20,5 · 24,5	50
EMCGV 12-090 LT	10106498	M 12x1,5	6	7 · 9	18	20,5 · 24,5	50
EMCGV 16-040 LT	10106499	M 16x1,5	6	2 · 4	22	22 · 26,5	50
EMCGV 16-060 LT	10106500	M 16x1,5	6	4 · 6	22	22 · 26,5	50
EMCGV 16-080 LT	10106501	M 16x1,5	6	6 · 8	22	22 · 26,5	50
EMCGV 16-100 LT	10106502	M 16x1,5	6	8 · 10	22	22 · 26,5	50
EMCGV 16-120 LT	10106503	M 16x1,5	6	10 · 12	22	22 · 26,5	50
EMCGV 20-060 LT	10106504	M 20x1,5	6	4 · 6	27	22 · 26,5	50
EMCGV 20-080 LT	10106505	M 20x1,5	6	6 · 8	27	22 · 26,5	50
EMCGV 20-100 LT	10106506	M 20x1,5	6	8 · 10	27	22 · 26,5	50
EMCGV 20-120 LT	10106507	M 20x1,5	6	10 · 12	27	22 · 26,5	50
EMCGV 20-140 LT	10106508	M 20x1,5	6	12 · 14	27	22 · 26,5	50
EMCGV 20-160 LT	10106509	M 20x1,5	6	14 · 16	27	22 · 26,5	50
EMCGV 25-080 LT	10106510	M 25x1,5	7	6 · 8	30	23 · 28	50
EMCGV 25-100 LT	10106511	M 25x1,5	7	8 · 10	30	23 · 28	50
EMCGV 25-120 LT	10106512	M 25x1,5	7	10 · 12	30	23 · 28	50
EMCGV 25-140 LT	10106513	M 25x1,5	7	12 · 14	30	23 · 28	50
EMCGV 25-160 LT	10106514	M 25x1,5	7	14 · 16	30	23 · 28	50
EMCGV 25-170 LT	10106515	M 25x1,5	7	15 · 17	30	23 · 28	50

Type	WISKA-No.	 D (mm)	 L (mm)	 (mm)	 SW (mm)	TL (mm)	
EMCGV 32-110 LT	10106516	M 32x1,5	8	9 · 11	36	24 · 28,5	25
EMCGV 32-130 LT	10106517	M 32x1,5	8	11 · 13	36	24 · 28,5	25
EMCGV 32-150 LT	10106518	M 32x1,5	8	13 · 15	36	24 · 28,5	25
EMCGV 32-180 LT	10106519	M 32x1,5	8	16 · 18	36	24 · 28,5	25
EMCGV 32-200 LT	10106520	M 32x1,5	8	18 · 20	36	24 · 28,5	25
EMCGV 32-230 LT	10106522	M 32x1,5	8	21 · 23	36	24 · 28,5	25
EMCGV 40-180 LT	10106523	M 40x1,5	8	16 · 18	45	24 · 28,5	10
EMCGV 40-200 LT	10106524	M 40x1,5	8	18 · 20	45	24 · 28,5	10
EMCGV 40-220 LT	10106525	M 40x1,5	8	20 · 22	45	24 · 28,5	10
EMCGV 40-240 LT	10106526	M 40x1,5	8	22 · 24	45	24 · 28,5	10
EMCGV 40-260 LT	10106527	M 40x1,5	8	24 · 26	45	24 · 28,5	10
EMCGV 40-290 LT	10106528	M 40x1,5	8	26 · 29	45	24 · 28,5	10
EMCGV 50-280 LT	10106529	M 50x1,5	9	26 · 28	55	25,5 · 30	10
EMCGV 50-300 LT	10106530	M 50x1,5	9	28 · 30	55	25,5 · 30	10
EMCGV 50-320 LT	10106589	M 50x1,5	9	30 · 32	55	25,5 · 30	10
EMCGV 50-340 LT	10106531	M 50x1,5	9	32 · 34	55	25,5 · 30	10
EMCGV 50-360 LT	10106532	M 50x1,5	9	34 · 36	55	25,5 · 30	10
EMCGV 50-380 LT	10106533	M 50x1,5	9	36 · 38	55	25,5 · 30	10
EMCGV 63-350 LT	10106534	M 63x1,5	10	33 · 35	68	26,5 · 31	10
EMCGV 63-380 LT	10106535	M 63x1,5	10	35 · 38	68	26,5 · 31	10
EMCGV 63-410 LT	10106536	M 63x1,5	10	38 · 41	68	26,5 · 31	10
EMCGV 63-440 LT	10106537	M 63x1,5	10	41 · 44	68	26,5 · 31	10
EMCGV 63-470 LT	10106538	M 63x1,5	10	44 · 47	68	26,5 · 31	10
EMCGV 63-490 LT	10106539	M 63x1,5	10	47 · 49	68	26,5 · 31	10

Acessórios Recomendados



EMMU

PLÁSTICO

METAL

MARÍTIMO

EMC

EX E/I

EX D

FERROVIÁRIO

EQUALIZAC /
VENTILAÇÃO

PADRÃO
BRITÂNICO

VEDAÇÕES

MEMBRANA

CONMAXX

CONMAXX
GLAND

BRACE
FITTING
PLÁSTICO

BRACE
CONDUIT
PLÁSTICO

BRACE
FITTING
METAL

BRACE
CONDUIT
METAL

SPRINT® Porcas de Fixação



EMMU



MMU



NMMU

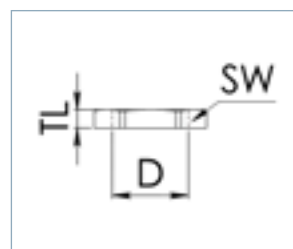

Material

Latão, niquelado

EMMU, métrica

Type	WISKA-No. Niquelado	D (mm)	SW (mm)	TL (mm)	
EMMU 8	10106828	M 8x1,25	11	2,5	100
EMMU 12	10063141	M 12x1,5	15	2,8	100
EMMU 16	10063142	M 16x1,5	19	2,8	100
EMMU 20	10063143	M 20x1,5	24	3	100
EMMU 25	10063144	M 25x1,5	30	3,5	100
EMMU 32	10063145	M 32x1,5	36	4	100
EMMU 40	10063146	M 40x1,5	46	5	50
EMMU 50	10063147	M 50x1,5	60	5	50
EMMU 63	10063148	M 63x1,5	70	6	50
EMMU 75	10101777	M 75x1,5	80	8	1

MMU, PG

Type	WISKA-No. Niquelado	D (mm)	SW (mm)	TL (mm)	
MMU 7	10062141	PG 7	15	2,8	100
MMU 9	10062142	PG 9	18	2,8	100
MMU 11	10062143	PG 11	21	3	100
MMU 13,5	10062144	PG 13,5	23	3	100
MMU 16	10062145	PG 16	26	3	100
MMU 21	10062146	PG 21	32	3,5	100
MMU 29	10062147	PG 29	41	4	100
MMU 36	10062148	PG 36	51	5	100
MMU 42	10062149	PG 42	60	5	50
MMU 48	10062150	PG 48	64	5	50

NMMU, NPT

Type	WISKA-No. Niquelado	D (mm)	SW (mm)	TL (mm)	
NMMU 1/4	10100972	NPT 1/4"	18	4	100
NMMU 3/8	10100973	NPT 3/8"	21	4	100
NMMU 1/2	10100974	NPT 1/2"	26	5,5	100
NMMU 3/4	10100975	NPT 3/4"	32	5,5	100
NMMU 1	10100976	NPT 1"	41	7	100
NMMU 1 1/4	10100977	NPT 1 1/4"	51	7	50
NMMU 1 1/2	10100978	NPT 1 1/2"	60	7	50
NMMU 2	10100979	NPT 2"	70	7	50

Bujão



EMVS



EMVS-L



EMVS-ORD

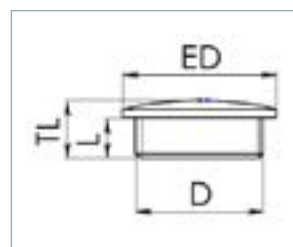

Classe de proteção
Conselhos
Material

IP54
com O-ring IP66 / IP68
Latão, niquelado

EMVS, métrica

Type	WISKA-No. Niquelado			ED (mm)	TL (mm)	
EMVS 12	10063151	M 12x1,5	5	14	7,5	100
EMVS 16	10063152	M 16x1,5	5	18	8	100
EMVS 20	10063153	M 20x1,5	6,5	22	9,5	100
EMVS 25	10063154	M 25x1,5	7	27	11	100
EMVS 32	10063155	M 32x1,5	8	35	12	50
EMVS 40	10063156	M 40x1,5	8,5	44	13	50
EMVS 50	10063157	M 50x1,5	9	54	15	25
EMVS 63	10063158	M 63x1,5	10	67	16	10



EMVS-L, longo, métrico

Type	WISKA-No. Niquelado			ED (mm)	TL (mm)	
EMVS-L 12	10065072	M 12x1,5	13	14	16	100
EMVS-L 16	10065073	M 16x1,5	13	18	16	100
EMVS-L 20	10065074	M 20x1,5	13	22	16	100
EMVS-L 25	10065075	M 25x1,5	14	27	18	100
EMVS-L 32	10065076	M 32x1,5	14,5	35	18,5	50
EMVS-L 40	10065077	M 40x1,5	14,5	44	19,5	50
EMVS-L 50	10065078	M 50x1,5	15,5	54	21	25
EMVS-L 63	10065079	M 63x1,5	16,5	67	22,5	10

MVS, PG

Type	WISKA-No. Niquelado			ED (mm)	TL (mm)	
MVS 7	10062151	PG 7	5	14	8	100
MVS 9	10062152	PG 9	6	17	9	100
MVS 11	10062153	PG 11	6	20	9	100
MVS 13,5	10062154	PG 13,5	6,5	22	9,5	100
MVS 16	10062155	PG 16	6,5	24	9,5	100
MVS 21	10062156	PG 21	7	30	10,5	100
MVS 29	10062157	PG 29	8	39	12	50
MVS 36	10062158	PG 36	9	50	14	50
MVS 42	10062159	PG 42	10	57	14,5	25
MVS 48	10062160	PG 48	10	64	14,5	25

EMVS-ORD, com vedação O-ring montado, métrica

Type	WISKA-No. Niquelado	 D (mm)	 t (mm)	ED (mm)	TL (mm)	
EMVS-ORD 12	10065080	M 12x1,5	5	14	7,5	100
EMVS-ORD 16	10065081	M 16x1,5	5	18	8	100
EMVS-ORD 20	10065082	M 20x1,5	6,5	22	9,5	100
EMVS-ORD 25	10065083	M 25x1,5	7	27	11	100
EMVS-ORD 32	10065084	M 32x1,5	8	35	12	50
EMVS-ORD 40	10065085	M 40x1,5	8,5	44	13	50
EMVS-ORD 50	10065086	M 50x1,5	9	54	15	25
EMVS-ORD 63	10065087	M 63x1,5	10	67	16	10

Acessórios Recomendados



EMMU

ORD-E

Adaptadores de ampliação



MEM





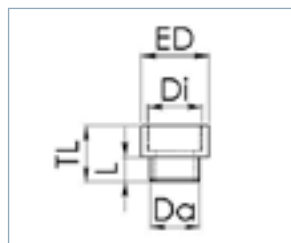

MEP







Material

Latão, niquelado

MEM, métrico-métrico

Type	WISKA-No. Niquelado	 Da (mm)	 Di (mm)	 t (mm)	ED (mm)	TL (mm)	
MEM 12/16	10063953	M 12x1,5	M 16x1,5	5	18	15	100
MEM 16/20	10063954	M 16x1,5	M 20x1,5	5	22	17	100
MEM 20/25	10063955	M 20x1,5	M 25x1,5	6	27	19	50
MEM 25/32	10063956	M 25x1,5	M 32x1,5	7	34	21	50
MEM 32/40	10063957	M 32x1,5	M 40x1,5	8	42	24	50
MEM 40/50	10063958	M 40x1,5	M 50x1,5	8	53	31	25
MEM 50/63	10063959	M 50x1,5	M 63x1,5	9	60	31	10

MEP, PG-PG

Type	WISKA-No. Niquelado	 Da (mm)	 Di (mm)	 L (mm)	ED (mm)	TL (mm)	
MEP 7 - 9	10062191	PG 7	PG 9	5	17	15	100
MEP 9 - 11	10062192	PG 9	PG 11	6	20	16,5	100
MEP 9 - 13,5	10062193	PG 9	PG 13,5	6	22	17,5	100
MEP 11 - 13,5	10062194	PG 11	PG 13,5	6	22	17,5	100
MEP 11 - 16	10062195	PG 11	PG 16	6	24	18,5	100
MEP 11 - 21	10062196	PG 11	PG 21	6	30	21	100
MEP 13,5 - 16	10062197	PG 13,5	PG 16	6,5	24	19	100
MEP 13,5 - 21	10062198	PG 13,5	PG 21	6,5	30	21	100
MEP 16 - 21	10062199	PG 16	PG 21	6,5	30	21	100
MEP 16 - 29	10062200	PG 16	PG 29	7	39	23	50
MEP 21 - 29	10062201	PG 21	PG 29	7	39	23	50
MEP 29 - 36	10062202	PG 29	PG 36	8	50	27,5	25
MEP 36 - 42	10062203	PG 36	PG 42	9	57	31	25
MEP 42 - 48	10062204	PG 42	PG 48	10	64	33	10

Accessórios Recomendados



EMMU ORD-E

Adaptadores de Redução



MRM





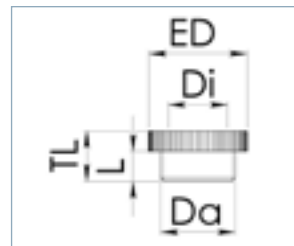

MRP



Material





Latão, niquelado

MRM, métrico-métrico

Type	WISKA-No. Niquelado	 Da (mm)	 Di (mm)	 L (mm)	ED (mm)	TL (mm)	
MRM 16/12	10063940	M 16x1,5	M 12x1,5	5	18	8	100
MRM 20/12	10063941	M 20x1,5	M 12x1,5	6	24	8,5	100
MRM 20/16	10063942	M 20x1,5	M 16x1,5	6	24	9	100
MRM 25/16	10063943	M 25x1,5	M 16x1,5	7	28	10	50
MRM 25/20	10063944	M 25x1,5	M 20x1,5	7	30	10	100
MRM 32/20	10063945	M 32x1,5	M 20x1,5	8	34	11,5	25
MRM 32/25	10063946	M 32x1,5	M 25x1,5	8	34	11,5	50
MRM 40/25	10063947	M 40x1,5	M 25x1,5	8	45	11,5	25
MRM 40/32	10063948	M 40x1,5	M 32x1,5	8	45	11,5	25
MRM 50/32	10063949	M 50x1,5	M 32x1,5	9	55	12,5	10
MRM 50/40	10063950	M 50x1,5	M 40x1,5	9	55	12,5	25
MRM 63/40	10063951	M 63x1,5	M 40x1,5	10	64	14	10
MRM 63/50	10063952	M 63x1,5	M 50x1,5	10	64	14	10

PLÁSTICO
METAL
MARÍTIMO
EMC
EX E/I
EX D
FERROVIÁRIO
EQUILIBRAÇÃO / VENTILAÇÃO
PADRÃO BRITÂNICO
VEDAÇÕES
MEMBRANA
CONMAXX
CONMAXX GLAND
BRACE FITTING PLÁSTICO
BRACE CONDUIT PLÁSTICO
BRACE FITTING METAL
BRACE CONDUIT METAL

MRP, PG-PG

Type	WISKA-No. Niquelado	 Da (mm)	 Di (mm)	 L (mm)	ED (mm)	TL (mm)	
MRP 9 - 7	10062161	PG 9	PG 7	6	17	8,5	100
MRP 11 - 7	10062162	PG 11	PG 7	6	20	8,5	100
MRP 11 - 9	10062163	PG 11	PG 9	6	20	8,5	100
MRP 13,5 - 7	10062164	PG 13,5	PG 7	6,5	22	9	100
MRP 13,5 - 9	10062165	PG 13,5	PG 9	6,5	22	9	100
MRP 13,5 - 11	10062166	PG 13,5	PG 11	6,5	22	9	100
MRP 16 - 7	10062167	PG 16	PG 7	6,5	24	9,5	100
MRP 16 - 9	10062168	PG 16	PG 9	6,5	24	9,5	100
MRP 16 - 11	10062169	PG 16	PG 11	6,5	24	9,5	100
MRP 16 - 13,5	10062170	PG 16	PG 13,5	6,5	24	9,5	100
MRP 21 - 11	10062171	PG 21	PG 11	7	30	10	50
MRP 21 - 13,5	10062172	PG 21	PG 13,5	7	30	10	50
MRP 21 - 16	10062173	PG 21	PG 16	7	30	10	50
MRP 29 - 13,5	10062174	PG 29	PG 13,5	8	39	11,5	50
MRP 29 - 16	10062175	PG 29	PG 16	8	39	11,5	50
MRP 29 - 21	10062176	PG 29	PG 21	8	39	11,5	50
MRP 36 - 21	10062177	PG 36	PG 21	9	50	12,5	25
MRP 36 - 29	10062178	PG 36	PG 29	9	50	12,5	25
MRP 42 - 29	10062179	PG 42	PG 29	10	57	14	25
MRP 42 - 36	10062180	PG 42	PG 36	10	57	14	25
MRP 48 - 36	10062181	PG 48	PG 36	10	64	14	25
MRP 48 - 42	10062182	PG 48	PG 42	10	64	14	25



Prensa Cabo de HatGLAND, pacote de HGSM, métrico



HGSM

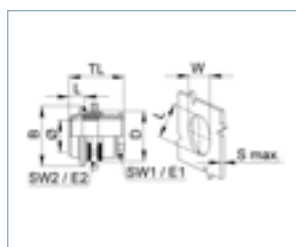

Classe de proteção
Conselhos
Material

IP68 (5 bar 30 min) / IP69
Incl. anéis de vedação, contra
Prensa Cabo de Aço inoxidável A2 (1.4305), Vedação de EPDM

HGSM, -40 °C · 120 °C

Type	WISKA-No.	D (mm)	(mm)	SW 1 (mm)	SW 2 (mm)	TL (mm)	LxWxS max (mm)	BxL (mm)	
HGSM 12-E Pack	10101853	M 12x0,75	2 - 5	9	15	15,5 - 20,5	10,5x12x4	17x6	1
HGSM 16-E Pack	10101854	M 16x0,75	2 - 9	12	19	17,5 - 24,5	14,5x16x5	21x7	1
HGSM 20-E Pack	10101855	M 20x0,75	3 - 12	17	24	19,5 - 27,5	18,5x20x5,5	25x8	1
HGSM 25-E Pack	10101856	M 25x0,75	4 - 16	21	30	19,5 - 27,5	23x25x5,5	30x8	1
HGSM 32-E Pack	10101857	M 32x0,75	9 - 23	28	36	27,5 - 39,5	30x32x10	38x11	1
HGSM 40-E Pack	10101858	M 40x1,5	16 - 29	35	46	33 - 47	37x40x10	46x14	1
HGSM 50-E Pack	10101859	M 50x1,5	26 - 38	45	60	37 - 53	47x50x10	56x16	1
HGSM 63-E Pack	10101860	M 63x1,5	32 - 49	56	70	42 - 60	59x63x10	70x18	1

HGSM FD, Alimentos, -60 °C · 180 °C

Type	WISKA-No.	D (mm)	(mm)	SW 1 (mm)	SW 2 (mm)	TL (mm)	LxWxS max (mm)	BxL (mm)	
HGSM 12 FD Pack	10103623	M 12x0,75	2 - 5	9	15	15,5 - 20,5	10,5x12x4	17x6	1
HGSM 16 FD Pack	10103624	M 16x0,75	2 - 9	12	19	17,5 - 24,5	14,5x16x5	21x7	1
HGSM 20 FD Pack	10103625	M 20x0,75	3 - 12	17	24	19,5 - 27,5	18,5x20x5,5	25x8	1
HGSM 25 FD Pack	10103626	M 25x0,75	4 - 16	21	30	19,5 - 27,5	23x25x5,5	30x8	1
HGSM 32 FD Pack	10103627	M 32x0,75	9 - 23	28	36	27,5 - 39,5	30x32x10	38x11	1
HGSM 40 FD Pack	10103628	M 40x1,5	16 - 29	35	46	33 - 47	37x40x10	46x14	1
HGSM 50 FD Pack	10103629	M 50x1,5	26 - 38	45	60	37 - 53	47x50x10	56x16	1
HGSM 63 FD Pack	10103630	M 63x1,5	32 - 49	56	70	42 - 60	59x63x10	70x18	1

HGSM LT, LowTemp, -60 °C · 180 °C

Type	WISKA-No.	D (mm)	(mm)	SW 1 (mm)	SW 2 (mm)	TL (mm)	LxWxS max (mm)	BxL (mm)	
HGSM 12-LT Pack	10102116	M 12x0,75	2 - 5	9	15	15,5 - 20,5	10,5x12x4	17x6	1
HGSM 16-LT Pack	10102117	M 16x0,75	2 - 9	12	19	17,5 - 24,5	14,5x16x5	21x7	1
HGSM 20-LT Pack	10102118	M 20x0,75	3 - 12	17	24	19,5 - 27,5	18,5x20x5,5	25x8	1
HGSM 25-LT Pack	10102119	M 25x0,75	4 - 16	21	30	19,5 - 27,5	23x25x5,5	30x8	1
HGSM 32-LT Pack	10102120	M 32x0,75	9 - 23	28	36	27,5 - 39,5	30x32x10	38x11	1
HGSM 40-LT Pack	10102121	M 40x1,5	16 - 29	35	46	33 - 47	37x40x10	46x14	1
HGSM 50-LT Pack	10102122	M 50x1,5	26 - 38	45	60	37 - 53	47x50x10	56x16	1
HGSM 63-LT Pack	10102123	M 63x1,5	32 - 49	56	70	42 - 60	59x63x10	70x18	1

Prensa Cabo SPRINT®, ESSKV, métrico, EN 62444



ESSKV



ESSKV-4

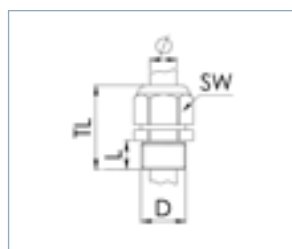

Classe de proteção IP68 (5 bar 30 min) / IP69
Faixa de temperatura -40 °C - 100 °C
Material Vedação de EPDM, Inserção de fixação Poliamida

ESSKV, aço inoxidável 1.4305

Type	WISKA-No.					TL (mm)	
ESSKV 12	10069000	M 12x1,5	5	3 · 7	17	23 · 30	10
ESSKV 16	10069001	M 16x1,5	5	4,5 · 10	22	26 · 34	10
ESSKV 20	10069002	M 20x1,5	6	6 · 13	24	29 · 37	10
ESSKV 25	10069003	M 25x1,5	7	9 · 17	30	33 · 42	10
ESSKV 32	10069004	M 32x1,5	8	13 · 21	36	36 · 44	5
ESSKV 40	10069005	M 40x1,5	8	16 · 28	46	44 · 55	5
ESSKV 50	10069006	M 50x1,5	9	21 · 35	55	51 · 62	2
ESSKV 63	10069007	M 63x1,5	10	34 · 48	68	56 · 67	1

ESSKV-4, aço inoxidável 1.4404

Type	WISKA-No.					TL (mm)	
ESSKV-4 12	10069100	M 12x1,5	5	3 · 7	17	23 · 30	10
ESSKV-4 16	10069101	M 16x1,5	5	4,5 · 10	22	26 · 34	10
ESSKV-4 20	10069102	M 20x1,5	6	6 · 13	24	29 · 37	10
ESSKV-4 25	10069103	M 25x1,5	7	9 · 17	30	33 · 42	10
ESSKV-4 32	10069104	M 32x1,5	8	13 · 21	36	36 · 44	5
ESSKV-4 40	10069105	M 40x1,5	8	16 · 28	46	44 · 55	5
ESSKV-4 50	10069106	M 50x1,5	9	21 · 35	55	51 · 62	2
ESSKV-4 63	10069107	M 63x1,5	10	34 · 48	68	56 · 67	1

Accessórios Recomendados



RDE

BS

ESMU

MFD

Prensa Cabo SPRINT® Baixa Temperatura LowTemp, ESKV LT, métrico, EN 62444



ESKLV LT



ESKLV-4 LT

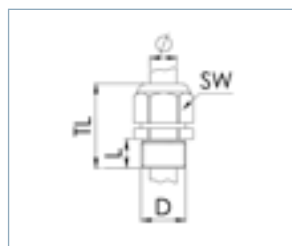

Classe de proteção IP68 (5 bar 30 min) / IP69
Faixa de temperatura -60 °C - 100 °C
Material Vedação de Silicone, Inserção de fixação Poliamida

ESKLV LT, aço inoxidável 1.4305

Type	WISKA-No.					TL (mm)	
ESKLV 12 LT	10065962	M 12x1,5	5	3 - 7	17	23 - 30	10
ESKLV 16 LT	10065963	M 16x1,5	5	4,5 - 10	22	26 - 34	10
ESKLV 20 LT	10065964	M 20x1,5	6	6 - 13	24	29 - 37	10
ESKLV 25 LT	10065965	M 25x1,5	7	9 - 17	30	33 - 42	10
ESKLV 32 LT	10065966	M 32x1,5	8	13 - 21	36	36 - 44	5
ESKLV 40 LT	10065967	M 40x1,5	8	16 - 28	46	44 - 55	5
ESKLV 50 LT	10065968	M 50x1,5	9	21 - 35	55	51 - 62	2
ESKLV 63 LT	10065969	M 63x1,5	10	34 - 48	68	56 - 67	1

ESKLV-4 LT, aço inoxidável 1.4404

Type	WISKA-No.					TL (mm)	
ESKLV-4 12 LT	10065881	M 12x1,5	5	3 - 7	17	23 - 30	10
ESKLV-4 16 LT	10065882	M 16x1,5	5	4,5 - 10	22	26 - 34	10
ESKLV-4 20 LT	10065883	M 20x1,5	6	6 - 13	24	29 - 37	10
ESKLV-4 25 LT	10065884	M 25x1,5	7	9 - 17	30	33 - 42	10
ESKLV-4 32 LT	10065885	M 32x1,5	8	13 - 21	36	36 - 44	5
ESKLV-4 40 LT	10065886	M 40x1,5	8	16 - 28	46	44 - 55	5
ESKLV-4 50 LT	10065887	M 50x1,5	9	21 - 35	55	51 - 62	2
ESKLV-4 63 LT	10065888	M 63x1,5	10	34 - 48	68	56 - 67	1

Acessórios Recomendados



RDE LT

BS

ESMU

Porcas de Fixação, ESMU, métrica

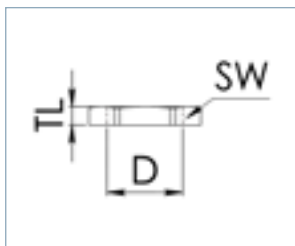



ESMU



Material

Aço inoxidável 1.4305

Type	WISKA-No.	 D (mm)	 SW (mm)	TL (mm)	
ESMU 12	10064188	M 12x1,5	15	2,8	10
ESMU 16	10064189	M 16x1,5	19	2,8	10
ESMU 20	10064190	M 20x1,5	24	3	10
ESMU 25	10064191	M 25x1,5	30	3,5	10
ESMU 32	10064192	M 32x1,5	36	4	5
ESMU 40	10064193	M 40x1,5	46	5	5
ESMU 50	10064194	M 50x1,5	60	5	2
ESMU 63	10064195	M 63x1,5	70	6	1

Bujão, ESVS, métrica



ESVS

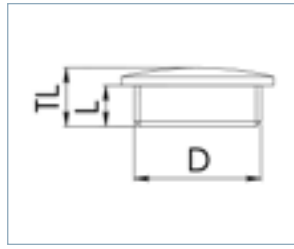

Classe de proteção
Conselhos
Material

IP54
com O-ring IP66 / IP68
Aço inoxidável 1.4305

Type	WISKA-No.			TL (mm)	
ESVS 12	10065460	M 12x1,5	5	7,5	10
ESVS 16	10065461	M 16x1,5	5	8	10
ESVS 20	10065462	M 20x1,5	6,5	9,5	10
ESVS 25	10065463	M 25x1,5	7	11	10
ESVS 32	10065464	M 32x1,5	8	12	5
ESVS 40	10065465	M 40x1,5	8,5	13	5
ESVS 50	10065466	M 50x1,5	9	15	2
ESVS 63	10065467	M 63x1,5	10	16	1

Acessórios Recomendados



ESMU

ORD-E

PLÁSTICO

METAL

MARÍTIMO

EMC

EX E/I

EX D

FERROVIÁRIO

EQUALIZAÇÃO / VENTILAÇÃO

PADRÃO BRITÂNICO

VEDAÇÕES

MEMBRANA

CONMAXX

CONMAXX GLAND

BRACE FITTING PLÁSTICO

BRACE CONDUIT PLÁSTICO

BRACE FITTING METAL

BRACE CONDUIT METAL

Prensa Cabo de MARATHON®, EZMGV-L, métrico

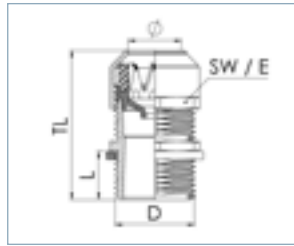

EZMGV-L

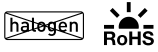

Classe de proteção
Faixa de temperatura
Material

IP66 / IP68
-40 °C - 80 °C
Prensa Cabo de Zinco niquelado, Vedação de EPDM, Inserção de fixação Poliamida / TPE

Type	WISKA-No.						
EZMGV-L 20	10108742	M 20x1,5	12	6 - 13	22	29 - 37	50

PLÁSTICO
METAL
MARITIM
EMC
EX E/I
EX D
FERROVIÁRIO
EQUILIZAC / VENTILACAO
PADRAO BRITANICO
VEDACOES
MEMBRANA
CONMAXX
CONMAXX GLAND
BRACE FITTING PLASTICO
BRACE CONDUIT PLASTICO
BRACE FITTING METAL
BRACE CONDUIT METAL



Prensa Cabo Marítimo

Se você procura prensa cabo para indústria marítima ou offshore nós oferecemos-lhe prensa cabo de latão e acessórios de acordo com DIN 89280 e DIN 89285. Estes são otimizados para uso em condições adversas em navios e instalações offshore.

Pressa Cabo SPRINT®, MMSKV®, métrico, DIN 89285



MMSKV



MMSKV EMV-Z

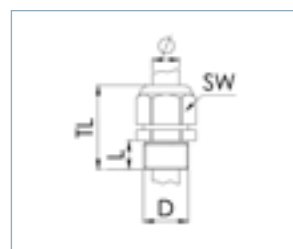

Classe de proteção
Faixa de temperatura
Material

IP68 (5 bar 30 min) / IP69
-40 °C - 100 °C
Pressa Cabo de Latão, Inserção de fixação Poliamida, Vedação de EPDM

MMSKV

Type	WISKA-No. Branco	WISKA-No. Niquelado	WISKA-No. Cromado	D (mm)	(mm)	(mm)	SW (mm)	TL (mm)	
MMSKV 16	10065101	10065108	10065115	M 16x1,5	9	4,5 - 10	20	30 - 38	1
MMSKV 18	10065102	10065109	10065116	M 18x1,5	10	6 - 13	24	33 - 41	1
MMSKV 24	10065103	10065110	10065117	M 24x1,5	11	9 - 17	29	37 - 46	1
MMSKV 30	10065104	10065111	10065118	M 30x2	12	13 - 21	36	40 - 48	1
MMSKV 36	10065105	10065112	10065119	M 36x2	13	16 - 28	46	49 - 60	1
MMSKV 45	10065106	10065113	10065120	M 45x2	14	21 - 35	55	56 - 67	1
MMSKV 56	10065107	10065114	10065121	M 56x2	15	34 - 48	68	61 - 72	1

MMSKV EMV-Z

Type	WISKA-No. Branco	WISKA-No. Niquelado	WISKA-No. Cromado	D (mm)	(mm)	(mm)	SW (mm)	TL (mm)	
MMSKV 16 EMV-Z	10065122	10065129	10065136	M 16x1,5	9	4,5 - 10	20	30 - 38	1
MMSKV 18 EMV-Z	10065123	10065130	10065137	M 18x1,5	10	6 - 13	24	33 - 41	1
MMSKV 24 EMV-Z	10065124	10065131	10065138	M 24x1,5	11	9 - 17	29	37 - 46	1
MMSKV 30 EMV-Z	10065125	10065132	10065139	M 30x2	12	13 - 21	36	40 - 48	1
MMSKV 36 EMV-Z	10065126	10065133	10065140	M 36x2	13	16 - 28	46	49 - 60	1
MMSKV 45 EMV-Z	10065127	10065134	10065141	M 45x2	14	21 - 35	55	56 - 67	1
MMSKV 56 EMV-Z	10065128	10065135	10065142	M 56x2	15	34 - 48	68	61 - 72	1

Acessórios Recomendados



RDE

MFD

GM

Pressa Cabos circular, KVM, métrico, DIN 89280



KVM



W-insert





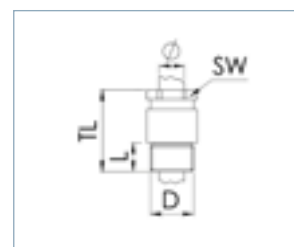

Z-insert



Classe de proteção
Faixa de temperatura
Conselhos
Material





IP54
 -40 °C - 100 °C
 * Semelhante a DIN 89280
 Pressa Cabo de Latão, Vedação de EPDM

KVM, tipo Z

Type	WISKA-No. Branco	WISKA-No. Niquelado	WISKA-No. Cromado	 D (mm)	 L (mm)	 (mm)	 SW (mm)	TL (mm)	
KVM 18-Z8	10010833	10013118	10014478	M 18x1,5	10	7 - 8,5	19	43	1
KVM 18-Z10	10010835	10010384	10014481	M 18x1,5	10	8 - 10,5	19	43	1
KVM 24-Z8A	10010836	10014480	10014482	M 24x1,5	11	7 - 8,5	24	49	1
KVM 24-Z10A	10010837	10014484	10014157	M 24x1,5	11	8 - 10,5	24	49	1
KVM 24-Z12	10010839	10012807	10014486	M 24x1,5	11	10 - 12,5	24	49	1
KVM 24-Z14	10010840	10012812	10014392	M 24x1,5	11	12 - 14,5	24	49	1
KVM 24-Z16	10010841	10014488	10014487	M 24x1,5	11	14 - 16,5	24	49	1
KVM 24-Z17	10010842	10014490	10014489	M 24x1,5	11	16 - 17,5	24	49	1
KVM 30-Z18	10010843	10013310	10014183	M 30x2	12	16 - 18,5	30	52	1
KVM 30-Z20	10010844	10013420	10014341	M 30x2	12	18 - 20,5	30	52	1
KVM 36-Z22	10010846	10013311	10014493	M 36x2	13	20 - 22,5	36	58	1
KVM 36-Z24	10010847	10014494	10014184	M 36x2	13	22 - 24,5	36	58	1
KVM 36-Z26	10010848	10014496	10014495	M 36x2	13	24 - 26,5	36	58	1
KVM 45-Z28	10010849	10014498	10014497	M 45x2	14	26 - 28,5	46	62	1
KVM 45-Z30	10010850	10014499	10014342	M 45x2	14	28 - 30,5	46	62	1
KVM 45-Z32	10010851	10013322	10014500	M 45x2	14	30 - 32,5	46	62	1
KVM 56-Z35	10010852	10014542	10014541	M 56x2	15	32 - 35,5	55	68	1
KVM 56-Z38	10010853	10013301	10014540	M 56x2	15	35 - 38,5	55	68	1
KVM 56-Z41	10010854	10013323	10014543	M 56x2	15	38 - 41,5	55	68	1
KVM 72-Z44	10010855	10014550	10014544	M 72x2	16	41 - 44,5	70	73	1
KVM 72-Z48	10010856	10013302	10014545	M 72x2	16	44 - 48,5	70	73	1
KVM 72-Z52	10010857	10014551	10014546	M 72x2	16	48 - 52,5	70	73	1
KVM 80-Z61*	10016543	10101672	10016581	M 80x2	18	59 - 62	85	79	1
KVM 80-Z64*	10010858	10014552	10014547	M 80x2	18	62 - 66	85	79	1
KVM 105-Z70*	10010859	10014553	10014548	M 105x2	20	68 - 73	105	88	1
KVM 105-Z75*	10010860	10014554	10014549	M 105x2	20	73 - 78	105	88	1

PLÁSTICO
 METAL
 MARÍTIMO
 EMC
 EX E/I
 EX D
 FERROVIÁRIO
 EQUALIZAÇ/
 VENTILAÇÃO
 PADRÃO
 BRITÂNICO
 VEDAÇÕES
 MEMBRANA
 CONMAXX
 CONMAXX
 GLAND
 BRACE
 FITTING
 PLÁSTICO
 BRACE
 CONDUIT
 PLÁSTICO
 BRACE
 FITTING
 METAL
 BRACE
 CONDUIT
 METAL

KVM, tipo W

	Type	WISKA-No. Branco	WISKA-No. Niquelado	WISKA-No. Cromado					TL (mm)	
PLÁSTICO	KVM 18-W8	10010862	10014561	10014562	M 18x1,5	10	7 - 8,5	19	43	1
	KVM 18-W10	10010863	10014563	10014564	M 18x1,5	10	8 - 10,5	19	43	1
METAL	KVM 24-W8A	10010864	10014565	10014566	M 24x1,5	11	7 - 8,5	24	49	1
	KVM 24-W10A	10010865	10013483	10014567	M 24x1,5	11	8 - 10,5	24	49	1
	KVM 24-W12	10010866	10014212	10014568	M 24x1,5	11	10 - 12,5	24	49	1
MARÍTIMO	KVM 24-W14	10010867	10012933	10014569	M 24x1,5	11	12 - 14,5	24	49	1
	KVM 24-W16	10010868	10014570	10014571	M 24x1,5	11	14 - 16,5	24	49	1
	KVM 24-W17	10010869	10014572	10014573	M 24x1,5	11	16 - 17,5	24	49	1
	KVM 30-W18	10010871	10014576	10014577	M 30x2	12	16 - 18,5	30	52	1
	KVM 30-W20	10010872	10014578	10014470	M 30x2	12	18 - 20,5	30	52	1
EMC	KVM 36-W22	10010875	10014582	10014583	M 36x2	13	20 - 22,5	36	58	1
	KVM 36-W24	10010876	10014584	10014585	M 36x2	13	22 - 24,5	36	58	1
	KVM 36-W26	10010877	10013069	10014586	M 36x2	13	24 - 26,5	36	58	1
	KVM 45-W28	10010878	10012299	10014587	M 45x2	14	26 - 28,5	46	62	1
EX E/I	KVM 45-W30	10010879	10014588	10014589	M 45x2	14	28 - 30,5	46	62	1
	KVM 45-W32	10010880	10014590	10014591	M 45x2	14	30 - 32,5	46	62	1
	KVM 56-W35	10010881	10014592	10014593	M 56x2	15	32 - 35,5	55	68	1
	KVM 56-W38	10010882	10014594	10014595	M 56x2	15	35 - 38,5	55	68	1
EX D	KVM 56-W41	10010883	10014596	10014597	M 56x2	15	38 - 41,5	55	68	1
	KVM 72-W44	10010884	10014598	10014599	M 72x2	16	41 - 44,5	70	73	1
	KVM 72-W48	10010885	10014600	10014601	M 72x2	16	44 - 48,5	70	73	1
FERROVIÁRIO	KVM 72-W52	10010886	10014602	10014603	M 72x2	16	48 - 52,5	70	73	1
	KVM 72-W56	10010887	10014311	10014604	M 72x2	16	52 - 56,5	70	73	1
	KVM 80-W61*	10016453	10016454	10016455	M 80x2	18	59 - 62	85	79	1
	KVM 80-W64*	10010888	10014605	10014606	M 80x2	18	62 - 66	85	79	1
EQUILIZAC/ VENTILACAO	KVM 105-W70*	10010890	10014607	10014608	M 105x2	20	68 - 73	105	88	1
	KVM 105-W75	10010891			M 105x2	20	73 - 78	105	88	1
	KVM 105-W80*	10010892	10016208	10014612	M 105x2	20	78 - 83	105	88	1
	KVM 105-W75*		10016207	10014610	M 105x2	20	73 - 78	105	88	1

Acessórios Recomendados



- BRITANICO
- VEDAÇÕES
- MEMBRANA
- CONNMAXX
- CONNMAXX GLAND
- BRACE FITTING PLÁSTICO
- BRACE CONDUIT PLÁSTICO
- BRACE FITTING METAL
- BRACE CONDUIT METAL

Porcas de Fixação, GM, métricas, DIN 89280

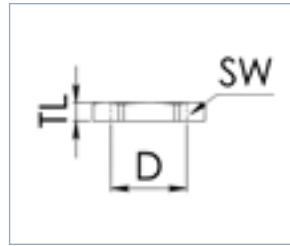



GM



**Conselhos
Material**

* Semelhante a DIN 89280
Latão

Type	WISKA-No. Branco	WISKA-No. Niquelado	WISKA-No. Cromado	 D (mm)	 SW (mm)	TL (mm)	
GM 16	50013662	10011606	10014237	M 16x1,5	22	4	1
GM 18	50011419	10012963	10011533	M 18x1,5	22	4	1
GM 24	50011420	10013175	10011532	M 24x1,5	30	5	1
GM 30	50011421	10012814	10011531	M 30x2	36	6	1
GM 36	50011422	10012815	10011530	M 36x2	41	7	1
GM 45	50011423	10011559	10011529	M 45x2	55	8	1
GM 56	50011424	10011557	10011528	M 56x2	65	9	1
GM 72	50011425	30070555	10012075	M 72x2	85	10	1
GM 80*	50011426	10014199	10011858	M 80x2	90	11	1
GM 105*	50011427	10011708	10103708	M 105x2	120	14	1

PLÁSTICO

METAL

MARÍTIMO

EMC

EX E/I

EX D

FERROVIÁRIO

EQUALIZAÇÃO /
VENTILAÇÃO

PADRÃO
BRITÂNICO

VEDAÇÕES

MEMBRANA

CONMAXX

CONMAXX
GLAND

BRACE
FITTING
PLÁSTICO

BRACE
CONDUIT
PLÁSTICO

BRACE
FITTING
METAL

BRACE
CONDUIT
METAL

Bujão, VSM, métrica, DIN 89284



VSM

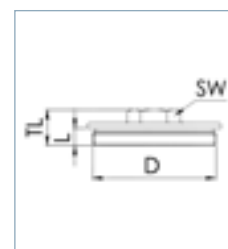
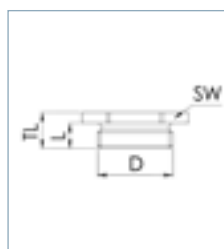

**Conselhos
Material**

* Semelhante a DIN 89280
Latão

Type	WISKA-No. Branco	WISKA-No. Niquelado	WISKA-No. Cromado				TL (mm)	Form	
VSM 16	50084870	50016772	50016782	M 16x1,5	8	22	11,5	A	1
VSM 18	50084875	10012980	10016783	M 18x1,5	8	22	11,5	A	1
VSM 20*	50084871	10016685	10016684	M 20x1,5	8	24	11,5	A	1
VSM 24	50084876	50016774	10016784	M 24x1,5	9	30	13	A	1
VSM 25*	50084872	50016687	50016686	M 25x1,5	9	30	13	A	1
VSM 30	50084877	50016775	50016785	M 30x2	10	36	14	A	1
VSM 32*	50084873	10016689	50016688	M 32x1,5	10	36	14	A	1
VSM 36	50084874	10016776	50016786	M 36x2	12	41	17	A	1
VSM 40*	50084670	10016691	10016690	M 40x1,5	12	22	22	B	1
VSM 45	50084671	10016777	10016787	M 45x2	12	22	22	B	1
VSM 50*	50084672	10016693	10016692	M 50x1,5	12	27	22	B	1
VSM 56	50084673	10016778	10016788	M 56x2	12	27	22	B	1
VSM 63*	50084674	10016695	10016694	M 63x1,5	12	27	22	B	1
VSM 72	50084675	10016779	10016789	M 72x2	12	27	22	B	1
VSM 75*	50084676	10016697	10016696	M 75x2	12	27	22	B	1
VSM 80*	50084677	10016780	10016790	M 80x2	12	27	22	B	1
VSM 105*	50084678	10016781	10016791	M 105x2	12	27	22	B	1



Prensa Cabos Ex

As tecnologias modernas estão constantemente se tornando mais exigentes e complexas. Isso aumenta a vulnerabilidade de componentes eletrônicos e distúrbios eletromagnéticos. Para proteger contra tais interações, oferecemos a você duas abordagens para os prensa-cabos da EMC, que garantem uma proteção efetiva de 360° e impermeabilidade durável para usos individuais com IP68 / 69.

Pressa Cabo SPRINT® EMC com mola de contato, EMSKV EMV-S, latão niquelado, métrico, EN 62444

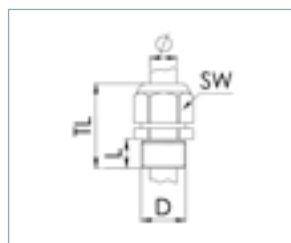

EMSKV EMV-S



Classe de proteção
Faixa de temperatura
Material

IP68 (5 bar 30 min) / IP69
-40 °C - 100 °C
Pressa Cabo de Latão niquelado, Inserção de fixação Poliamida, Vedação de EPDM, Inserção de mola de contacto: Aço inoxidável 1.4310

EMSKV EMV-S

Type	WISKA-No. Niquelado						TL (mm)	
EMSKV 12 EMV-S	10102273	M 12x1,5	5	3 - 7	2 - 6	16	23 - 30	50
EMSKV 16 EMV-S	10102274	M 16x1,5	5	4,5 - 10	3 - 9	20	26 - 34	50
EMSKV 20 EMV-S	10102275	M 20x1,5	6	6 - 13	5 - 12	24	29 - 37	50
EMSKV 25 EMV-S	10102276	M 25x1,5	7	9 - 17	7,5 - 13,5	29	33 - 42	50
EMSKV 32 EMV-S	10102277	M 32x1,5	8	13 - 21	11 - 19	36	36 - 44	25
EMSKV 40 EMV-S	10102278	M 40x1,5	8	16 - 28	14 - 26	46	44 - 55	10
EMSKV 50 EMV-S	10102279	M 50x1,5	9	21 - 35	18 - 32	55	51 - 62	10
EMSKV 63 EMV-S	10102280	M 63x1,5	10	34 - 48	30 - 44	68	56 - 67	10

EMSKV-L EMV-S, longo

Type	WISKA-No. Niquelado						TL (mm)	
EMSKV-L 12 EMV-S	10102645	M 12x1,5	12	3 - 7	2 - 6	16	30 - 37	50
EMSKV-L 16 EMV-S	10102646	M 16x1,5	12	4,5 - 10	3 - 9	20	33 - 41	50
EMSKV-L 20 EMV-S	10102647	M 20x1,5	12	6 - 13	5 - 12	24	35 - 43	50
EMSKV-L 25 EMV-S	10102648	M 25x1,5	12	9 - 17	7,5 - 13,5	29	38 - 47	50
EMSKV-L 32 EMV-S	10102649	M 32x1,5	15	13 - 21	11 - 19	36	43 - 51	25
EMSKV-L 40 EMV-S	10102650	M 40x1,5	15	16 - 28	14 - 26	46	51 - 62	10
EMSKV-L 50 EMV-S	10102651	M 50x1,5	15	21 - 35	18 - 32	55	57 - 68	10
EMSKV-L 63 EMV-S	10102652	M 63x1,5	15	34 - 48	30 - 44	68	61 - 72	10

Acessórios Recomendados



Prensa Cabo SPRINT® EMC com cone de aterramento DIN 89345, EMSKV EMV-Z, latão niquelado, métrico, EN 62444

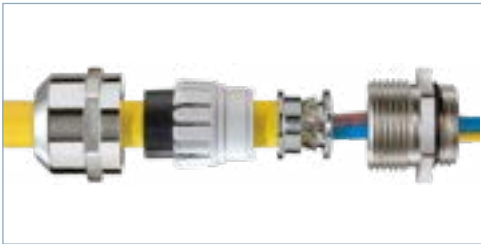

EMSKV EMV-Z

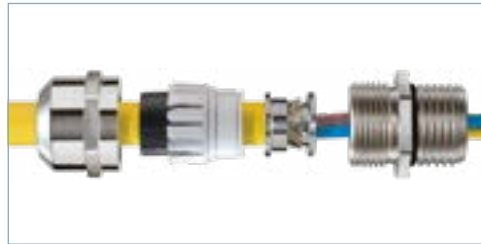

EMSKV-L EMV-Z

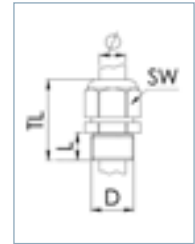

Classe de proteção
Faixa de temperatura
Material

IP68 (5 bar 30 min) / IP69

-40 °C - 100 °C

Prensa Cabo de Latão niquelado, Inserção de fixação Poliamida, Vedação de EPDM, Cones de aterramento: Latão cromado

EMSKV EMV-Z

Type	WISKA-No. Niquelado	D (mm)	L (mm)	Ø (mm)	Ø (mm)	SW (mm)	TL (mm)	
EMSKV 12 EMV-Z	10065016	M 12x1,5	5	3 - 7	5	16	23 - 30	50
EMSKV 16 EMV-Z	10065017	M 16x1,5	5	4,5 - 10	7,5	20	26 - 34	50
EMSKV 20 EMV-Z	10065018	M 20x1,5	6	6 - 13	9,5	24	29 - 37	50
EMSKV 25 EMV-Z	10065019	M 25x1,5	7	9 - 17	16	29	33 - 42	50
EMSKV 32 EMV-Z	10065020	M 32x1,5	8	13 - 21	20	36	36 - 44	25
EMSKV 40 EMV-Z	10065021	M 40x1,5	8	16 - 28	26	46	44 - 55	10
EMSKV 50 EMV-Z	10065022	M 50x1,5	9	21 - 35	33	55	51 - 62	10
EMSKV 63 EMV-Z	10065023	M 63x1,5	10	34 - 48	45	68	56 - 67	10
EMSKV 75 EMV-Z	10100963	M 75x1,5	12	48 - 62	58	82	67 - 81	1

EMSKV-L EMV-Z, longo

Type	WISKA-No. Niquelado	D (mm)	L (mm)	Ø (mm)	Ø (mm)	SW (mm)	TL (mm)	
EMSKV-L 12 EMV-Z	10065182	M 12x1,5	12	3 - 7	5	16	30 - 37	50
EMSKV-L 16 EMV-Z	10065183	M 16x1,5	12	4,5 - 10	7,5	20	33 - 41	50
EMSKV-L 20 EMV-Z	10065184	M 20x1,5	12	6 - 13	9,5	24	35 - 43	50
EMSKV-L 25 EMV-Z	10065185	M 25x1,5	12	9 - 17	16	29	38 - 47	50
EMSKV-L 32 EMV-Z	10065186	M 32x1,5	15	13 - 21	20	36	43 - 51	25
EMSKV-L 40 EMV-Z	10065187	M 40x1,5	15	16 - 28	26	46	51 - 62	10
EMSKV-L 50 EMV-Z	10065188	M 50x1,5	15	21 - 35	33	55	57 - 68	10
EMSKV-L 63 EMV-Z	10065189	M 63x1,5	15	34 - 48	45	68	61 - 72	10

Acessórios Recomendados



RDE

EMMU-EMV

BS

PLÁSTICO
METAL
MARÍTIMO
EMC
EX E/I
EX D
FERROVIÁRIO
EQUILIBRAÇÃO / VENTILAÇÃO
PADRÃO BRITÂNICO
VEDAÇÕES
MEMBRANA
CONMAXX
CONMAXX GLAND
BRACE FITTING PLÁSTICO
BRACE CONDUIT PLÁSTICO
BRACE FITTING METAL
BRACE CONDUIT METAL

Pressa Cabos de Compressão ShotGLAND EMV com cones de aterramento DIN 89345, EMCGV EMV-Z, latão, métrico, EN 62444





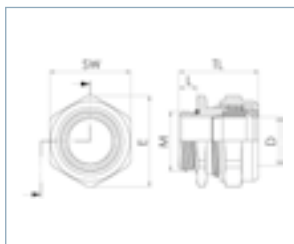







EMCGV EMV-Z



Classe de proteção
Faixa de temperatura
Material

IP68 (5 bar 30 min)
-40° C - 120 °C
Pressa Cabo de Latão niquelado, Vedação de EPDM, Cones de aterramento:
Latão cromado

Type	WISKA-No.	 D (mm)	 (mm)	 (mm)	 SW (mm)	TL (mm)	
EMCGV 8-030 EMV-Z	10106442	M 8x1,25	5	2 - 3,3	11	15 - 18,5	50
EMCGV 8-040 EMV-Z	10106443	M 8x1,25	5	3 - 4,3	11	15 - 18,5	50
EMCGV 8-050 EMV-Z	10106445	M 8x1,25	5	4 - 5,3	11	15 - 18,5	50
EMCGV 12-030 EMV-Z	10106446	M 12x1,5	6	2 - 3	18	20,5 - 24,5	50
EMCGV 12-050 EMV-Z	10106447	M 12x1,5	6	3 - 5	18	20,5 - 24,5	50
EMCGV 12-070 EMV-Z	10106448	M 12x1,5	6	5 - 7	18	20,5 - 24,5	50
EMCGV 12-090 EMV-Z	10106449	M 12x1,5	6	7 - 9	18	20,5 - 24,5	50
EMCGV 16-040 EMV-Z	10106450	M 16x1,5	6	2 - 4	22	22 - 26,5	50
EMCGV 16-060 EMV-Z	10106451	M 16x1,5	6	4 - 6	22	22 - 26,5	50
EMCGV 16-080 EMV-Z	10106452	M 16x1,5	6	6 - 8	22	22 - 26,5	50
EMCGV 16-100 EMV-Z	10106453	M 16x1,5	6	8 - 10	22	22 - 26,5	50
EMCGV 16-120 EMV-Z	10106454	M 16x1,5	6	10 - 12	22	22 - 26,5	50
EMCGV 20-060 EMV-Z	10106455	M 20x1,5	6	4 - 6	27	22 - 26,5	50
EMCGV 20-080 EMV-Z	10106456	M 20x1,5	6	6 - 8	27	22 - 26,5	50
EMCGV 20-100 EMV-Z	10106457	M 20x1,5	6	8 - 10	27	22 - 26,5	50
EMCGV 20-120 EMV-Z	10106458	M 20x1,5	6	10 - 12	27	22 - 26,5	50
EMCGV 20-140 EMV-Z	10106459	M 20x1,5	6	12 - 14	27	22 - 26,5	50
EMCGV 20-160 EMV-Z	10106460	M 20x1,5	6	14 - 16	27	22 - 26,5	50
EMCGV 25-080 EMV-Z	10106461	M 25x1,5	7	6 - 8	30	23 - 28	50
EMCGV 25-100 EMV-Z	10106462	M 25x1,5	7	8 - 10	30	23 - 28	50
EMCGV 25-120 EMV-Z	10106463	M 25x1,5	7	10 - 12	30	23 - 28	50
EMCGV 25-140 EMV-Z	10106464	M 25x1,5	7	12 - 14	30	23 - 28	50
EMCGV 25-160 EMV-Z	10106465	M 25x1,5	7	14 - 16	30	23 - 28	50
EMCGV 25-170 EMV-Z	10106466	M 25x1,5	7	15 - 17	30	23 - 28	50
EMCGV 32-110 EMV-Z	10106467	M 32x1,5	8	9 - 11	36	24 - 28,5	25
EMCGV 32-130 EMV-Z	10106468	M 32x1,5	8	11 - 13	36	24 - 28,5	25
EMCGV 32-150 EMV-Z	10106469	M 32x1,5	8	13 - 15	36	24 - 28,5	25
EMCGV 32-180 EMV-Z	10106470	M 32x1,5	8	16 - 18	36	24 - 28,5	25
EMCGV 32-200 EMV-Z	10106471	M 32x1,5	8	18 - 20	36	24 - 28,5	25
EMCGV 32-230 EMV-Z	10106473	M 32x1,5	8	21 - 23	36	24 - 28,5	25
EMCGV 40-180 EMV-Z	10106474	M 40x1,5	8	16 - 18	45	24 - 28,5	10
EMCGV 40-200 EMV-Z	10106475	M 40x1,5	8	18 - 20	45	24 - 28,5	10
EMCGV 40-220 EMV-Z	10106476	M 40x1,5	8	20 - 22	45	24 - 28,5	10
EMCGV 40-240 EMV-Z	10106477	M 40x1,5	8	22 - 24	45	24 - 28,5	10
EMCGV 40-260 EMV-Z	10106478	M 40x1,5	8	24 - 26	45	24 - 28,5	10
EMCGV 40-290 EMV-Z	10106479	M 40x1,5	8	26 - 29	45	24 - 28,5	10
EMCGV 50-280 EMV-Z	10106480	M 50x1,5	9	26 - 28	55	25,5 - 30	10
EMCGV 50-300 EMV-Z	10106481	M 50x1,5	9	28 - 30	55	25,5 - 30	10
EMCGV 50-320 EMV-Z	10106482	M 50x1,5	9	30 - 32	55	25,5 - 30	10
EMCGV 50-340 EMV-Z	10106483	M 50x1,5	9	32 - 34	55	25,5 - 30	10
EMCGV 50-360 EMV-Z	10106484	M 50x1,5	9	34 - 36	55	25,5 - 30	10
EMCGV 50-380 EMV-Z	10106485	M 50x1,5	9	36 - 38	55	25,5 - 30	10

Type	WISKA-No.	 D (mm)	 L (mm)	 (mm)	 SW (mm)	TL (mm)	
EMCGV 63-350 EMV-Z	10106486	M 63x1,5	10	33 - 35	68	26,5 - 31	10
EMCGV 63-380 EMV-Z	10106487	M 63x1,5	10	35 - 38	68	26,5 - 31	10
EMCGV 63-410 EMV-Z	10106488	M 63x1,5	10	38 - 41	68	26,5 - 31	10
EMCGV 63-440 EMV-Z	10106489	M 63x1,5	10	41 - 44	68	26,5 - 31	10
EMCGV 63-470 EMV-Z	10106490	M 63x1,5	10	44 - 47	68	26,5 - 31	10
EMCGV 63-490 EMV-Z	10106491	M 63x1,5	10	47 - 49	68	26,5 - 31	10

ShotGLAND EMV-Prensa cabo e compressão Baixa Temperatura LowTemp com aterramento DIN 89345, EMCGV LT EMV-Z, Secagem, métrico, EN 62444





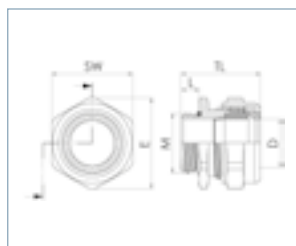

EMCGV LT EMV-Z







Classe de proteção
Faixa de temperatura
Material

IP68 (5 bar 30 min)
-60 °C - 180 °C
Prensa Cabo de Latão niquelado, Vedação de Silicone, Cones de aterramento: Latão cromado

Type	WISKA-No.	 D (mm)	 L (mm)	 (mm)	 SW (mm)	TL (mm)	
EMCGV 8-030 LT EMV-Z	10106540	M 8x1,25	5	2 - 3,3	11	15 - 18,5	50
EMCGV 8-040 LT EMV-Z	10106541	M 8x1,25	5	3 - 4,3	11	15 - 18,5	50
EMCGV 8-050 LT EMV-Z	10106542	M 8x1,25	5	4 - 5,3	11	15 - 18,5	50
EMCGV 12-030 LT EMV-Z	10106543	M 12x1,5	6	2 - 3	18	20,5 - 24,5	50
EMCGV 12-050 LT EMV-Z	10106544	M 12x1,5	6	3 - 5	18	20,5 - 24,5	50
EMCGV 12-070 LT EMV-Z	10106545	M 12x1,5	6	5 - 7	18	20,5 - 24,5	50
EMCGV 12-090 LT EMV-Z	10106546	M 12x1,5	6	7 - 9	18	20,5 - 24,5	50
EMCGV 16-040 LT EMV-Z	10106547	M 16x1,5	6	2 - 4	22	22 - 26,5	50
EMCGV 16-060 LT EMV-Z	10106548	M 16x1,5	6	4 - 6	22	22 - 26,5	50
EMCGV 16-080 LT EMV-Z	10106549	M 16x1,5	6	6 - 8	22	22 - 26,5	50
EMCGV 16-100 LT EMV-Z	10106550	M 16x1,5	6	8 - 10	22	22 - 26,5	50
EMCGV 16-120 LT EMV-Z	10106551	M 16x1,5	6	10 - 12	22	22 - 26,5	50
EMCGV 20-060 LT EMV-Z	10106552	M 20x1,5	6	4 - 6	27	22 - 26,5	50
EMCGV 20-080 LT EMV-Z	10106553	M 20x1,5	6	6 - 8	27	22 - 26,5	50
EMCGV 20-100 LT EMV-Z	10106554	M 20x1,5	6	8 - 10	27	22 - 26,5	50
EMCGV 20-120 LT EMV-Z	10106555	M 20x1,5	6	10 - 12	27	22 - 26,5	50
EMCGV 20-140 LT EMV-Z	10106556	M 20x1,5	6	12 - 14	27	22 - 26,5	50
EMCGV 20-160 LT EMV-Z	10106557	M 20x1,5	6	14 - 16	27	22 - 26,5	50
EMCGV 25-080 LT EMV-Z	10106558	M 25x1,5	7	6 - 8	30	23 - 28	50
EMCGV 25-100 LT EMV-Z	10106559	M 25x1,5	7	8 - 10	30	23 - 28	50
EMCGV 25-120 LT EMV-Z	10106560	M 25x1,5	7	10 - 12	30	23 - 28	50
EMCGV 25-140 LT EMV-Z	10106561	M 25x1,5	7	12 - 14	30	23 - 28	50
EMCGV 25-160 LT EMV-Z	10106562	M 25x1,5	7	14 - 16	30	23 - 28	50
EMCGV 25-170 LT EMV-Z	10106563	M 25x1,5	7	15 - 17	30	23 - 28	50
EMCGV 32-110 LT EMV-Z	10106564	M 32x1,5	8	9 - 11	36	24 - 28,5	25
EMCGV 32-130 LT EMV-Z	10106565	M 32x1,5	8	11 - 13	36	24 - 28,5	25
EMCGV 32-150 LT EMV-Z	10106566	M 32x1,5	8	13 - 15	36	24 - 28,5	25
EMCGV 32-180 LT EMV-Z	10106567	M 32x1,5	8	16 - 18	36	24 - 28,5	25
EMCGV 32-200 LT EMV-Z	10106568	M 32x1,5	8	18 - 20	36	24 - 28,5	25
EMCGV 32-230 LT EMV-Z	10106570	M 32x1,5	8	21 - 23	36	24 - 28,5	25

PLÁSTICO
METAL
MARÍTIMO
EMC
EX E/I
EX D
FERROVIÁRIO
EQUILIBRAÇÃO / VENTILAÇÃO
PADRÃO BRITÂNICO
VEDAÇÕES
MEMBRANA
CONMAXX
CONMAXX GLAND
BRACE FITTING PLÁSTICO
BRACE CONDUIT PLÁSTICO
BRACE FITTING METAL
BRACE CONDUIT METAL

	Type	WISKA-No.					TL (mm)	
PLÁSTICO	EMCGV 40-180 LT EMV-Z	10106571	M 40x1,5	8	16 · 18	45	24 · 28,5	10
	EMCGV 40-200 LT EMV-Z	10106572	M 40x1,5	8	18 · 20	45	24 · 28,5	10
	EMCGV 40-220 LT EMV-Z	10106573	M 40x1,5	8	20 · 22	45	24 · 28,5	10
METAL	EMCGV 40-240 LT EMV-Z	10106574	M 40x1,5	8	22 · 24	45	24 · 28,5	10
	EMCGV 40-260 LT EMV-Z	10106575	M 40x1,5	8	24 · 26	45	24 · 28,5	10
	EMCGV 40-290 LT EMV-Z	10106576	M 40x1,5	8	26 · 29	45	24 · 28,5	10
MARÍTIMO	EMCGV 50-280 LT EMV-Z	10106577	M 50x1,5	9	26 · 28	55	25,5 · 30	10
	EMCGV 50-300 LT EMV-Z	10106578	M 50x1,5	9	28 · 30	55	25,5 · 30	10
	EMCGV 50-320 LT EMV-Z	10106579	M 50x1,5	9	30 · 32	55	25,5 · 30	10
EMC	EMCGV 50-340 LT EMV-Z	10106580	M 50x1,5	9	32 · 34	55	25,5 · 30	10
	EMCGV 50-360 LT EMV-Z	10106581	M 50x1,5	9	34 · 36	55	25,5 · 30	10
	EMCGV 50-380 LT EMV-Z	10106582	M 50x1,5	9	36 · 38	55	25,5 · 30	10
EX E/I	EMCGV 63-350 LT EMV-Z	10106583	M 63x1,5	10	33 · 35	68	26,5 · 31	10
	EMCGV 63-380 LT EMV-Z	10106584	M 63x1,5	10	35 · 38	68	26,5 · 31	10
	EMCGV 63-410 LT EMV-Z	10106585	M 63x1,5	10	38 · 41	68	26,5 · 31	10
EX D	EMCGV 63-440 LT EMV-Z	10106586	M 63x1,5	10	41 · 44	68	26,5 · 31	10
	EMCGV 63-470 LT EMV-Z	10106587	M 63x1,5	10	44 · 47	68	26,5 · 31	10
	EMCGV 63-490 LT EMV-Z	10106588	M 63x1,5	10	47 · 49	68	26,5 · 31	10

EX D

FERROVIÁRIO

EQUILIZAC/
VENTILAÇÃOPADRÃO
BRITÂNICO

VEDAÇÕES

MEMBRANA

CONMAXX

CONMAXX
GLANDBRACE
FITTING
PLÁSTICOBRACE
CONDUIT
PLÁSTICOBRACE
FITTING
METALBRACE
CONDUIT
METAL

Prensa Cabo SPRINT® EMC com cone de aterramento para DIN 89345, EE, cromado de latão





EE



Conselhos Material

* Semelhante DIN 89345
Latão, cromado

Type	WISKA-No. Cromado	 (mm)		
EE 10-03*	50101021	3	HatGLAND 12	1
EE 12-05*	50085887	5	SPRINT 12	1
EE 14-07*	50101022	7	HatGLAND 16	1
EE 16-06	50084648	6	SPRINT 16 / KVM 16	1
EE 16-07*	50085652	7,5	SPRINT 16 / KVM 16	1
EE 18-06	50084649	6	SPRINT20 / KVM18 / HatGLAND20	1
EE 18-07	50080958	7	SPRINT20 / KVM18 / HatGLAND20	1
EE 18-09*	50085650	9,5	SPRINT20 / KVM18 / HatGLAND20	1
EE 22-14*	50101023	14,5	HatGLAND 25	1
EE 24-06	50084650	6	SPRINT 25 / KVM 24	1
EE 24-07	50080960	7	SPRINT 25 / KVM 24	1
EE 24-08	50084651	8	SPRINT 25 / KVM 24	1
EE 24-10	50080962	10,5	SPRINT 25 / KVM 24	1
EE 24-13	50080963	13	SPRINT 25 / KVM 24	1
EE 24-14	50080964	14,5	SPRINT 25 / KVM 24	1
EE 24-16*	50085654	16	SPRINT 25 / KVM 24	1
EE 30-16	50084652	16	SPRINT32 / KVM30 / HatGLAND32	1
EE 30-18	50081743	18	SPRINT32 / KVM30 / HatGLAND32	1
EE 30-20*	50085655	20	SPRINT32 / KVM30 / HatGLAND32	1
EE 36-20	50080967	20	SPRINT40 / KVM36 / HatGLAND40	1
EE 36-22	50084653	22	SPRINT40 / KVM36 / HatGLAND40	1
EE 36-24	50080969	24	SPRINT40 / KVM36 / HatGLAND40	1
EE 36-26*	50085656	26	SPRINT40 / KVM36 / HatGLAND40	1
EE 45-27	50081592	27	SPRINT50 / KVM45 / HatGLAND50	1
EE 45-30	50081407	30	SPRINT50 / KVM45 / HatGLAND50	1
EE 45-33*	50085657	33	SPRINT50 / KVM45 / HatGLAND50	1
EE 56-35	50081406	35	SPRINT63 / KVM56 / HatGLAND63	1
EE 56-39	50080768	39	SPRINT63 / KVM56 / HatGLAND63	1
EE 56-45*	50085658	45	SPRINT63 / KVM56 / HatGLAND63	1
EE 72-49	50080954	49	KVM 72	1
EE 72-44	50080955	44	KVM 72	1
EE 72-58	50085659	58	KVM 72	1
EE 80-62*	50082650	62	KVM 80	1
EE 105-72*	50084654	72	KVM 105	1
EE 105-77*	50084655	77	KVM 105	1

Porcas de fixação EMC, latão niquelado



EMMU-EMV



MMU-EMV

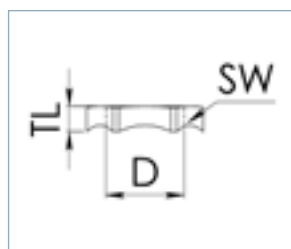



Material

Latão, niquelado

EMMU-EMV, métrica

Type	WISKA-No. Niquelado	 D (mm)	 SW (mm)	TL (mm)	
EMMU-EMV 12	10063210	M 12x1,5	15	4,7	100
EMMU-EMV 16	10063211	M 16x1,5	19	4,7	100
EMMU-EMV 20	10063212	M 20x1,5	24	4,7	100
EMMU-EMV 25	10063213	M 25x1,5	30	5,2	100
EMMU-EMV 32	10063214	M 32x1,5	36	5,7	100
EMMU-EMV 40	10063215	M 40x1,5	46	6,5	50
EMMU-EMV 50	10063216	M 50x1,5	60	7	50
EMMU-EMV 63	10063217	M 63x1,5	70	7	25
EMMU-EMV 75	10102228	M 75x1,5	80	10	1

MMU-EMV, PG

Type	WISKA-No. Niquelado	 D (mm)	 SW (mm)	TL (mm)	
MMU-EMV 7	10063218	PG 7	15	4,7	100
MMU-EMV 9	10063219	PG 9	18	4,7	100
MMU-EMV 11	10063220	PG 11	21	4,7	100
MMU-EMV 13,5	10063221	PG 13,5	23	4,7	100
MMU-EMV 16	10063222	PG 16	26	4,7	100
MMU-EMV 21	10063223	PG 21	32	5,2	50
MMU-EMV 29	10063224	PG 29	41	5,7	50
MMU-EMV 36	10063225	PG 36	51	6,5	50
MMU-EMV 42	10063226	PG 42	60	7	50
MMU-EMV 48	10063227	PG 48	64	7	50

Prensa Cabo SPRINT® EMC com cone de aterramento DIN 89345, ESKV EMV-Z, aço inoxidável, métrico, EN 62444



ESKV EMV-Z

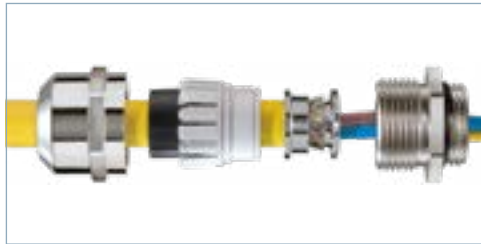

ESKV-4 EMV-Z

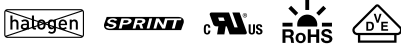
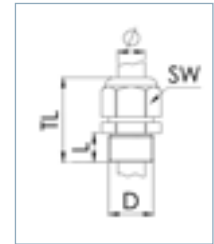

Classe de proteção IP68 (5 bar 30 min) / IP69
Faixa de temperatura -40 °C - 100 °C
Material Prensa Cabo de Aço inoxidável A2 (1.4305), Inserção de fixação Poliamida, Vedação de EPDM, Cones de aterramento: Latão cromado

ESKV EMV-Z, aço inoxidável 1.4305

Type	WISKA-No.						TL (mm)	
ESKV 12 EMV-Z	10069016	M 12x1,5	5	3 - 7	5	17	23 - 30	10
ESKV 16 EMV-Z	10069017	M 16x1,5	5	4,5 - 10	7,5	22	26 - 34	10
ESKV 20 EMV-Z	10069018	M 20x1,5	6	6 - 13	9,5	24	29 - 37	10
ESKV 25 EMV-Z	10069019	M 25x1,5	7	9 - 17	16	30	33 - 42	10
ESKV 32 EMV-Z	10069020	M 32x1,5	8	13 - 21	20	36	36 - 44	5
ESKV 40 EMV-Z	10069021	M 40x1,5	8	16 - 28	26	46	44 - 55	5
ESKV 50 EMV-Z	10069022	M 50x1,5	9	21 - 35	33	55	51 - 62	2
ESKV 63 EMV-Z	10069023	M 63x1,5	10	34 - 48	45	68	56 - 67	1

ESKV-4 EMV-Z, aço inoxidável 1.4404

Type	WISKA-No.						TL (mm)	
ESKV-4 12 EMV-Z	10069116	M 12x1,5	5	3 - 7	5	17	23 - 30	10
ESKV-4 16 EMV-Z	10069117	M 16x1,5	5	4,5 - 10	7,5	22	26 - 34	10
ESKV-4 20 EMV-Z	10069118	M 20x1,5	6	6 - 13	9,5	24	29 - 37	10
ESKV-4 25 EMV-Z	10069119	M 25x1,5	7	9 - 17	16	30	33 - 42	10
ESKV-4 32 EMV-Z	10069120	M 32x1,5	8	13 - 21	20	36	36 - 44	5
ESKV-4 40 EMV-Z	10069121	M 40x1,5	8	16 - 28	26	46	44 - 55	5
ESKV-4 50 EMV-Z	10069122	M 50x1,5	9	21 - 35	33	55	51 - 62	2
ESKV-4 63 EMV-Z	10069123	M 63x1,5	10	34 - 48	45	68	56 - 67	1

Accessórios Recomendados



RDE

BS

ESMU

PLÁSTICO
 METAL
 MARÍTIMO
 EMC
 EX E/I
 EX D
 FERROVIÁRIO
 EQUALIZAÇ/
 VENTILAÇÃO
 PADRÃO
 BRITÂNICO
 VEDAÇÕES
 MEMBRANA
 CONMAXX
 CONMAXX
 GLAND
 BRACE
 FITTING
 PLÁSTICO
 BRACE
 CONDUIT
 PLÁSTICO
 BRACE
 FITTING
 METAL
 BRACE
 CONDUIT
 METAL

Inserto de mola de contato SPRINT® EMC, EMV-S, aço inoxidável







EMV-S



Material

Aço inoxidável 1.4310

Type	WISKA-No.	 (mm)	 (mm)		
EMV-S 12	10102528	2 · 6	3 · 7	SPRINT 12	5
EMV-S 16	10102529	3 · 9	4,5 · 10	SPRINT 16	5
EMV-S 20	10102530	5 · 12	6 · 13	SPRINT 20	5
EMV-S 25	10102531	7,5 · 13,5	9 · 17	SPRINT 25	5
EMV-S 32	10102532	11 · 19	13 · 21	SPRINT 32	5
EMV-S 40	10102533	14 · 26	16 · 28	SPRINT 40	1
EMV-S 50	10102534	18 · 32	21 · 35	SPRINT 50	1
EMV-S 63	10102535	30 · 44	34 · 48	SPRINT 63	1

PLÁSTICO

METAL

MARITIM

EMC

EX / E / I

EX D

FERROVIÁRIO

EQUALIZAC /
VENTILAÇÃO

PADRAO
BRITANICO

VEDAÇÕES

MEMBRANA

CONMAXX

CONMAXX
GLAND

BRACE
FITTING
PLASTICO

BRACE
CONDUIT
PLASTICO

BRACE
FITTING
METAL

BRACE
CONDUIT
METAL



Prensa Cabos Ex

Para áreas potencialmente explosivas em plataformas de petróleo, em armazéns de produtos perigosos ou na indústria química, temos nossos prensa cabo Ex com diferentes tipos de proteção de acordo as normas ATEX e IECEx. Seja para invólucros à prova de explosão, segurança aumentada ou segurança intrínseca - nosso portfólio Ex varia os prensa cabos, roscas de travamento de conexão, assim com os adaptadores e reduções.

Pressa Cabo SPRINT® EX, ESKE/1-e, segurança aumentada, poliamida, métrica



ESKE/1-e



ESKE/1-L-e

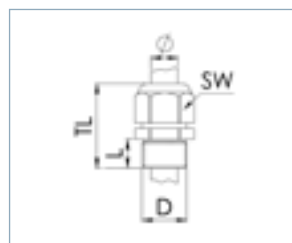

Marcação

Aprovação

Classe de proteção

Teste de fio incandescente

Faixa de temperatura

Material

II 2 D Ex tb IIIC Db / II 2 G Ex eb IIC Gb

IECEx PTB 13.0034X / PTB 13 ATEX 1015 X

IP66 / IP68 (5 bar 30 min)

750 °C

-40 °C · 75 °C

Pressa Cabo de Poliamida, Vedação de EPDM

ESKE/1-e

Type	WISKA-No. RAL 9005				SW (mm)	TL (mm)	
ESKE/1-e 12	10103363	M 12x1,5	9	3 · 6	16	29 · 34	50
ESKE/1-e 16	10103364	M 16x1,5	9	4,5 · 9	20	31 · 37	50
ESKE/1-e 20	10103365	M 20x1,5	10	7 · 13	24	36 · 45	50
ESKE/1-e 25	10103366	M 25x1,5	10	10 · 17	29	38 · 47	50
ESKE/1-e 32	10103367	M 32x1,5	12	13 · 21	36	42 · 51	25
ESKE/1-e 40	10103368	M 40x1,5	12	17 · 28	46	52 · 65	10
ESKE/1-e 50	10103369	M 50x1,5	14	23 · 35	55	59 · 72	4
ESKE/1-e 63	10103370	M 63x1,5	15	34 · 48	68	64 · 78	1

ESKE/1-L-e, longo

Type	WISKA-No. RAL 9005				SW (mm)	TL (mm)	
ESKE/1-L-e 12	10103379	M 12x1,5	15	3 · 6	16	35 · 40	50
ESKE/1-L-e 16	10103380	M 16x1,5	15	4,5 · 9	20	37 · 43	50
ESKE/1-L-e 20	10103381	M 20x1,5	15	7 · 13	24	41 · 48	50
ESKE/1-L-e 25	10103382	M 25x1,5	15	10 · 17	29	43 · 51	50
ESKE/1-L-e 32	10103383	M 32x1,5	15	13 · 21	36	45 · 53	25
ESKE/1-L-e 40	10103384	M 40x1,5	18	17 · 28	46	58 · 71	10
ESKE/1-L-e 50	10103385	M 50x1,5	18	23 · 35	55	63 · 76	4
ESKE/1-L-e 63	10103386	M 63x1,5	18	34 · 48	68	67 · 81	1

Acessórios Recomendados



EMUG

RDE

BS

Pressa Cabo SPRINT® EX Baixa Temperatura LowTemp, ESKE/1-e LT, segurança aumentada, poliamida, métrica



ESKE/1-e LT



ESKE/1-L-e LT

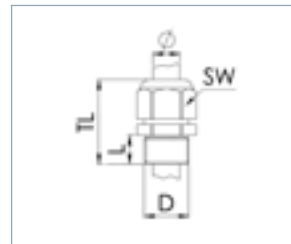

Marcação

Aprovação

Classe de proteção

Teste de fio incandescente

Faixa de temperatura

Material

II 2 D Ex tb IIIC Db / II 2 G Ex eb IIC Gb

IECEx PTB 13.0034X / PTB 13 ATEX 1015 X

IP66 / IP68 (5 bar 30 min)

750 °C

-60 °C - 75 °C

Pressa Cabo de Poliamida, Vedação de Silicone

ESKE/1-e LT

Type	WISKA-No. RAL 9005					TL (mm)	
ESKE/1-e 12 LT	10103429	M 12x1,5	9	3 - 6	16	29 - 34	50
ESKE/1-e 16 LT	10103430	M 16x1,5	9	4,5 - 9	20	31 - 37	50
ESKE/1-e 20 LT	10103431	M 20x1,5	10	7 - 13	24	36 - 45	50
ESKE/1-e 25 LT	10103432	M 25x1,5	10	10 - 17	29	38 - 47	50
ESKE/1-e 32 LT	10103433	M 32x1,5	12	13 - 21	36	42 - 51	25
ESKE/1-e 40 LT	10103434	M 40x1,5	12	17 - 28	46	52 - 65	10
ESKE/1-e 50 LT	10103435	M 50x1,5	14	23 - 35	55	59 - 72	4
ESKE/1-e 63 LT	10103436	M 63x1,5	15	34 - 48	68	64 - 78	1

ESKE/1-L-e LT, longo

Type	WISKA-No. RAL 9005					TL (mm)	
ESKE/1-L-e 12 LT	10103445	M 12x1,5	15	3 - 6	16	35 - 40	50
ESKE/1-L-e 16 LT	10103446	M 16x1,5	15	4,5 - 9	20	37 - 43	50
ESKE/1-L-e 20 LT	10103447	M 20x1,5	15	7 - 13	24	41 - 48	50
ESKE/1-L-e 25 LT	10103448	M 25x1,5	15	10 - 17	29	43 - 51	50
ESKE/1-L-e 32 LT	10103449	M 32x1,5	15	13 - 21	36	45 - 53	25
ESKE/1-L-e 40 LT	10103450	M 40x1,5	18	17 - 28	46	58 - 71	10
ESKE/1-L-e 50 LT	10103451	M 50x1,5	18	23 - 35	55	63 - 76	4
ESKE/1-L-e 63 LT	10103452	M 63x1,5	18	34 - 48	68	67 - 81	1

Acessórios Recomendados



EMUG

RDE LT

BS

Prensa Cabo SPRINT® EX com proteção flexível, ESKE/1S-e, segurança aumentada, poliamida, métrica



ESKE/1S-e



ESKE/1S-L-e

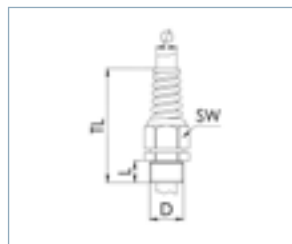

Marcação

Aprovação

Classe de proteção

Teste de fio incandescente

Faixa de temperatura

Material

II 2 D Ex tb IIIC Db / II 2 G Ex eb IIC Gb

IECEx PTB 13.0034X / PTB 13 ATEX 1015 X

IP66 / IP68 (5 bar 30 min)

750 °C

-40 °C · 75 °C

Prensa Cabo de Poliamida, Vedação de EPDM

ESKE/1S-e

Type	WISKA-No. RAL 9005	D (mm)	L (mm)	Ø (mm)	SW (mm)	TL (mm)	
ESKE/1S-e 12	10103493	M 12x1,5	9	3 · 6	16	72 · 77	50
ESKE/1S-e 16	10103494	M 16x1,5	9	4,5 · 9	20	82 · 88	50
ESKE/1S-e 20	10103495	M 20x1,5	10	7 · 13	24	103 · 112	50
ESKE/1S-e 25	10103496	M 25x1,5	10	10 · 17	29	119 · 128	25
ESKE/1S-e 32	10103497	M 32x1,5	12	13 · 21	36	138 · 147	10

ESKE/1S-L-e, longo

Type	WISKA-No. RAL 9005	D (mm)	L (mm)	Ø (mm)	SW (mm)	TL (mm)	
ESKE/1S-L-e 12	10103503	M 12x1,5	15	3 · 6	16	78 · 83	50
ESKE/1S-L-e 16	10103504	M 16x1,5	15	4,5 · 9	20	88 · 94	50
ESKE/1S-L-e 20	10103505	M 20x1,5	15	7 · 13	24	108 · 117	50
ESKE/1S-L-e 25	10103506	M 25x1,5	15	10 · 17	29	124 · 133	50
ESKE/1S-L-e 32	10103507	M 32x1,5	15	13 · 21	36	141 · 150	10

Acessórios Recomendados



EMUG

RDE

BS

Pressa Cabo SPRINT® EX, ESKE/1-i, para segurança intrínseca, poliamida, métrica



ESKE/1-i



ESKE/1-L-i

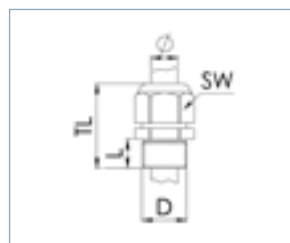

Marcação

Aprovação

Classe de proteção

Teste de fio incandescente

Faixa de temperatura

Material

II 2 D Ex tb IIIC Db · II 2 G Ex eb IIC Gb

IECEx PTB 13.0034X · PTB 13 ATEX 1015 X

IP66 / IP68 (5 bar 30 min)

750 °C

-40 °C · 75 °C

Pressa Cabo de Poliamida, Vedação de EPDM

ESKE/1-i

Type	WISKA-No. RAL 5012 / RAL 9005					TL (mm)	
ESKE/1-i 12	10103371	M 12x1,5	9	3 · 6	16	31 · 37	50
ESKE/1-i 16	10103372	M 16x1,5	9	4,5 · 9	20	31 · 37	50
ESKE/1-i 20	10103373	M 20x1,5	10	7 · 13	24	36 · 45	50
ESKE/1-i 25	10103374	M 25x1,5	10	10 · 17	29	38 · 47	50
ESKE/1-i 32	10103375	M 32x1,5	12	13 · 21	36	42 · 51	25
ESKE/1-i 40	10103376	M 40x1,5	12	17 · 28	46	52 · 65	10
ESKE/1-i 50	10103377	M 50x1,5	14	23 · 35	55	59 · 72	4
ESKE/1-i 63	10103378	M 63x1,5	15	34 · 48	68	64 · 78	1

ESKE/1-L-i, longo

Type	WISKA-No. RAL 5012 / RAL 9005					TL (mm)	
ESKE/1-L-i 12	10103387	M 12x1,5	15	3 · 6	16	35 · 45	50
ESKE/1-L-i 16	10103388	M 16x1,5	15	4,5 · 9	20	37 · 43	50
ESKE/1-L-i 20	10103389	M 20x1,5	15	7 · 13	24	41 · 48	50
ESKE/1-L-i 25	10103390	M 25x1,5	15	10 · 17	29	43 · 51	50
ESKE/1-L-i 32	10103391	M 32x1,5	15	13 · 21	36	45 · 53	25
ESKE/1-L-i 40	10103392	M 40x1,5	18	17 · 28	46	58 · 71	10
ESKE/1-L-i 50	10103393	M 50x1,5	18	23 · 35	55	63 · 76	4
ESKE/1-L-i 63	10103394	M 63x1,5	18	34 · 48	68	67 · 81	1

Acessórios Recomendados



EMUG

RDE

BS

Pressa Cabo SPRINT® EX Baixa Temperatura LowTemp, ESKE/1-i LT, para segurança intrínseca, poliamida, métrica



ESKE/1-i LT



ESKE/1-L-i LT

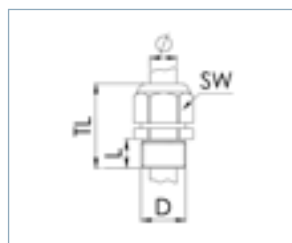

Marcação

Aprovação

Classe de proteção

Teste de fio incandescente

Faixa de temperatura

Material

II 2 D Ex tb IIIC Db / II 2 G Ex eb IIC Gb

IECEx PTB 13.0034X / PTB 13 ATEX 1015 X





IP66 / IP68 (5 bar 30 min)

750 °C





-60 °C - 75 °C

Pressa Cabo de Poliamida, Vedação de Silicone

ESKE/1-i LT

Type	WISKA-No.					TL (mm)	
ESKE/1-i 12 LT	10103437	M 12x1,5	9	3 · 6	16	31 · 37	50
ESKE/1-i 16 LT	10103438	M 16x1,5	9	4,5 · 9	20	31 · 37	50
ESKE/1-i 20 LT	10103439	M 20x1,5	10	7 · 13	24	36 · 45	50
ESKE/1-i 25 LT	10103440	M 25x1,5	10	10 · 17	29	38 · 47	50
ESKE/1-i 32 LT	10103441	M 32x1,5	12	13 · 21	36	42 · 51	25
ESKE/1-i 40 LT	10103442	M 40x1,5	12	17 · 28	46	52 · 65	10
ESKE/1-i 50 LT	10103443	M 50x1,5	14	23 · 35	55	59 · 72	4
ESKE/1-i 63 LT	10103444	M 63x1,5	15	34 · 48	68	64 · 78	1

ESKE/1-L-i LT, longo

Type	WISKA-No.					TL (mm)	
ESKE/1-L-i 12 LT	10103453	M 12x1,5	15	3 · 6	16	35 · 45	50
ESKE/1-L-i 16 LT	10103454	M 16x1,5	15	4,5 · 9	20	37 · 43	50
ESKE/1-L-i 20 LT	10103455	M 20x1,5	15	7 · 13	24	41 · 48	50
ESKE/1-L-i 25 LT	10103456	M 25x1,5	15	10 · 17	29	43 · 51	50
ESKE/1-L-i 32 LT	10103457	M 32x1,5	15	13 · 21	36	45 · 53	25
ESKE/1-L-i 40 LT	10103458	M 40x1,5	18	17 · 28	46	58 · 71	10
ESKE/1-L-i 50 LT	10103459	M 50x1,5	18	23 · 35	55	63 · 76	4
ESKE/1-L-i 63 LT	10103460	M 63x1,5	18	34 · 48	68	67 · 81	1

Acessórios Recomendados



EMUG

RDE LT

BS

EX stop termina, EX-EVSG, poliamida, métrica

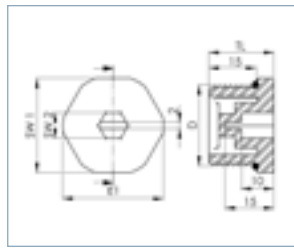

EX-EVSG

**Marcação****Aprovação****Classe de proteção****Faixa de temperatura****Material**

II 2 D Ex tb IIIC Db / II 2 G Ex eb IIC Gb

IECEX PTB 16.0025X / PTB 06 ATEX 1032 X

IP66 / IP68 (5 bar 30 min)

-40 °C - 75 °C

Poliamida, Vedação de EPDM

Type	WISKA-No. RAL 9005	D (mm)	L (mm)	SW 1 (mm)	SW 2 (mm)	TL (mm)	
EX-EVSG 12	10065300	M 12x1,5	15	16	6	19	100
EX-EVSG 16	10065301	M 16x1,5	15	20	8	19	100
EX-EVSG 20	10065302	M 20x1,5	15	24	8	19	100
EX-EVSG 25	10065303	M 25x1,5	15	29	8	20	100
EX-EVSG 32	10065304	M 32x1,5	15	36	8	20	50
EX-EVSG 40	10065305	M 40x1,5	15	46	8	20	30
EX-EVSG 50	10065306	M 50x1,5	15	55	8	20	30
EX-EVSG 63	10065307	M 63x1,5	15	68	8	20	30
EX-EVSG 75	10065308	M 75x1,5	15	82	8	20	2

Acessórios Recomendados

PLÁSTICO

METAL

MARÍTIMO

EMC

EX E/I

EX D

FERROVIÁRIO

EQUILIBRAÇÃO /
VENTILAÇÃOPADRÃO
BRITÂNICO

VEDAÇÕES

MEMBRANA

CONMAXX

CONMAXX
GLANDBRACE
FITTING
PLÁSTICOBRACE
CONDUIT
PLÁSTICOBRACE
FITTING
METALBRACE
CONDUIT
METAL

Adaptadores de ampliação EX, EX-KEM, poliamida, métrico-métrico

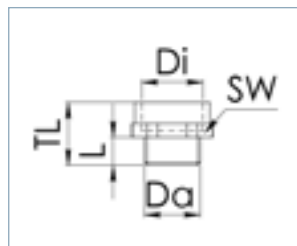

EX-KEM

**Marcação****Aprovação****Classe de proteção****Faixa de temperatura****Material**

II 2 D Ex tb IIIC Db / II 2 G Ex eb IIC Gb
 IECEx PTB 16.0026X / PTB 04 ATEX 1040 X
 IP66 / IP68 (5 bar 30 min)
 -40 °C - 75 °C
 Poliamida, reforçada com fibra

Type	WISKA-No. RAL 9005	Da (mm)	Di (mm)	TL (mm)	SW (mm)	TL (mm)	
EX-KEM 12/16	10064741	M 12x1,5	M 16x1,5	9	20	27	100
EX-KEM 16/20	10064742	M 16x1,5	M 20x1,5	9	24	27	100
EX-KEM 20/25	10064743	M 20x1,5	M 25x1,5	9	29	27	100
EX-KEM 25/32	10064744	M 25x1,5	M 32x1,5	10	36	28	100
EX-KEM 32/40	10064745	M 32x1,5	M 40x1,5	12	46	30	50
EX-KEM 40/50	10064746	M 40x1,5	M 50x1,5	12	55	30	25
EX-KEM 50/63	10064747	M 50x1,5	M 63x1,5	14	68	32	5

Acessórios Recomendados

EMUG

Adaptadores de redução EX, EX-KRM, poliamida, métrico-métrico



EX-KRM Form A



EX-KRM Form B

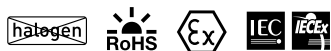
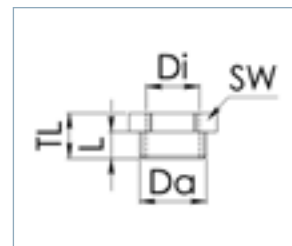
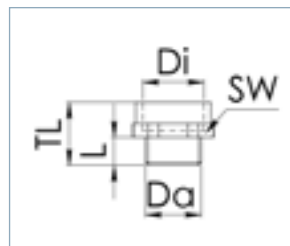

Marcação





Aprovação

Classe de proteção

Faixa de temperatura

Material

II 2 D Ex tb IIIC Db / II 2 G Ex eb IIC Gb
 IECEx PTB 16.0026X / PTB 04 ATEX 1040 X
 IP66 / IP68 (5 bar 30 min)
 -40 °C - 75 °C
 Poliamida, reforçada com fibra

Type	WISKA-No. RAL 9005	 Da (mm)	 Di (mm)	 TL (mm)	 SW (mm)	TL (mm)	Form	
EX-KRM 16/12	10064720	M 16x1,5	M 12x1,5	9	20	27	A	100
EX-KRM 20/12	10064721	M 20x1,5	M 12x1,5	9	24	16	B	100
EX-KRM 20/16	10064722	M 20x1,5	M 16x1,5	9	24	27	A	100
EX-KRM 25/12	10064723	M 25x1,5	M 12x1,5	10	29	17	B	100
EX-KRM 25/16	10064724	M 25x1,5	M 16x1,5	10	29	17	B	100
EX-KRM 25/20	10064725	M 25x1,5	M 20x1,5	10	29	17	B	100
EX-KRM 32/16	10064726	M 32x1,5	M 16x1,5	12	36	19	B	50
EX-KRM 32/20	10064727	M 32x1,5	M 20x1,5	12	36	19	B	50
EX-KRM 32/25	10064728	M 32x1,5	M 25x1,5	12	36	19	B	50
EX-KRM 40/20	10064729	M 40x1,5	M 20x1,5	12	46	19	B	25
EX-KRM 40/25	10064730	M 40x1,5	M 25x1,5	12	46	19	B	25
EX-KRM 40/32	10064731	M 40x1,5	M 32x1,5	12	46	19	B	25
EX-KRM 50/20	10064732	M 50x1,5	M 20x1,5	14	55	21	B	5
EX-KRM 50/25	10064733	M 50x1,5	M 25x1,5	14	55	21	B	5
EX-KRM 50/32	10064734	M 50x1,5	M 32x1,5	14	55	21	B	5
EX-KRM 50/40	10064735	M 50x1,5	M 40x1,5	14	55	21	B	5
EX-KRM 63/20	10064736	M 63x1,5	M 20x1,5	15	68	22	B	5
EX-KRM 63/25	10064737	M 63x1,5	M 25x1,5	15	68	22	B	5
EX-KRM 63/32	10064738	M 63x1,5	M 32x1,5	15	68	22	B	5
EX-KRM 63/40	10064739	M 63x1,5	M 40x1,5	15	68	22	B	5
EX-KRM 63/50	10064740	M 63x1,5	M 50x1,5	15	68	22	B	5

Acessórios Recomendados



EMUG

PLÁSTICO

METAL

MARÍTIMO

EMC

EX E/I

EX D

FERROVIÁRIO

EQUILIBRAÇÃO /
VENTILAÇÃOPADRÃO
BRITÂNICO

VEDAÇÕES

MEMBRANA

CONMAXX

CONMAXX
GLANDBRACE
FITTING
PLÁSTICOBRACE
CONDUIT
PLÁSTICOBRACE
FITTING
METALBRACE
CONDUIT
METAL

Adaptadores EX, EX-APM, poliamida, PG-métrica



EX-APM Form A

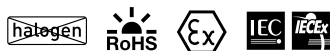
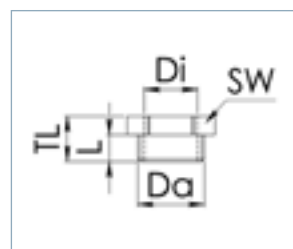
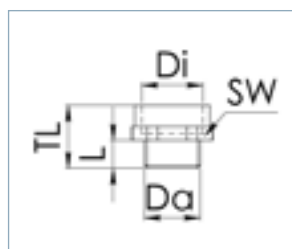

EX-APM Form B

**Marcação****Aprovação****Classe de proteção****Faixa de temperatura****Material**

II 2 D Ex tb IIIC Db / II 2 G Ex eb IIC Gb

IECEx PTB 16.0026X / PTB 04 ATEX 1040 X

IP66 / IP68 (5 bar 30 min)

-40 °C - 75 °C

Poliamida, reforçada com fibra

Type	WISKA-No. RAL 9005					TL (mm)	Form	
EX-APM 7/12	10064748	PG 7	M 12x1,5	9	16	27	A	25
EX-APM 7/16	10064749	PG 7	M 16x1,5	9	20	27	A	25
EX-APM 9/12	10064750	PG 9	M 12x1,5	9	20	27	A	25
EX-APM 9/16	10064751	PG 9	M 16x1,5	9	20	27	A	25
EX-APM 9/20	10064752	PG 9	M 20x1,5	9	24	27	A	25
EX-APM 11/16	10064753	PG 11	M 16x1,5	9	22	27	A	25
EX-APM 11/20	10064754	PG 11	M 20x1,5	9	24	27	A	25
EX-APM 11/25	10064755	PG 11	M 25x1,5	9	29	27	A	25
EX-APM 13,5/16	10064756	PG 13,5	M 16x1,5	10	24	28	A	25
EX-APM 13,5/20	10064757	PG 13,5	M 20x1,5	10	24	28	A	25
EX-APM 13,5/25	10064758	PG 13,5	M 25x1,5	10	29	28	A	25
EX-APM 16/20	10064759	PG 16	M 20x1,5	10	27	28	A	25
EX-APM 16/25	10064760	PG 16	M 25x1,5	10	29	28	A	25
EX-APM 16/32	10064761	PG 16	M 32x1,5	10	36	28	A	25
EX-APM 21/20	10064762	PG 21	M 20x1,5	12	33	19	B	10
EX-APM 21/25	10064763	PG 21	M 25x1,5	12	33	30	A	10
EX-APM 21/32	10064764	PG 21	M 32x1,5	12	36	30	A	10
EX-APM 21/40	10064765	PG 21	M 40x1,5	12	46	30	A	10
EX-APM 29/20	10064766	PG 29	M 20x1,5	12	42	19	B	10
EX-APM 29/25	10064767	PG 29	M 25x1,5	12	42	19	B	10
EX-APM 29/32	10064768	PG 29	M 32x1,5	12	42	19	B	10
EX-APM 29/40	10064769	PG 29	M 40x1,5	12	46	30	A	10
EX-APM 29/50	10064770	PG 29	M 50x1,5	12	55	30	A	10
EX-APM 36/20	10064771	PG 36	M 20x1,5	14	53	21	B	10
EX-APM 36/25	10064772	PG 36	M 25x1,5	14	53	21	B	10
EX-APM 36/32	10064773	PG 36	M 32x1,5	14	53	21	B	10
EX-APM 36/40	10064774	PG 36	M 40x1,5	14	53	21	B	10
EX-APM 36/50	10064775	PG 36	M 50x1,5	14	55	32	A	10
EX-APM 36/63	10064776	PG 36	M 63x1,5	14	68	32	A	10
EX-APM 42/20	10064777	PG 42	M 20x1,5	14	60	21	B	5
EX-APM 42/25	10064778	PG 42	M 25x1,5	14	60	21	B	5
EX-APM 42/32	10064779	PG 42	M 32x1,5	14	60	21	B	5
EX-APM 42/40	10064780	PG 42	M 40x1,5	14	60	21	B	5
EX-APM 42/50	10064781	PG 42	M 50x1,5	14	60	32	A	5
EX-APM 42/63	10064782	PG 42	M 63x1,5	14	68	32	A	5
EX-APM 48/20	10064783	PG 48	M 20x1,5	15	65	22	B	5
EX-APM 48/25	10064784	PG 48	M 25x1,5	15	65	22	B	5
EX-APM 48/32	10064785	PG 48	M 32x1,5	15	65	22	B	5
EX-APM 48/40	10064786	PG 48	M 40x1,5	15	65	22	B	5
EX-APM 48/50	10064787	PG 48	M 50x1,5	15	65	22	B	5
EX-APM 48/63	10064788	PG 48	M 63x1,5	15	68	33	A	5

Prensa Cabo SPRINT® EX, EMSKE, latão niquelado, métrico



EMSKE



EMSKE-L

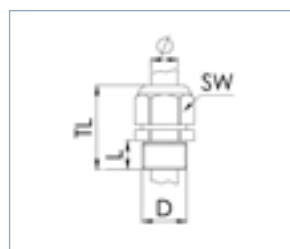

Marcação

Aprovação

Classe de proteção

Faixa de temperatura

Material

II 2 D Ex tb IIIC Db / II 2 G Ex eb IIC Gb
IECEx PTB 13.0027X / PTB 04 ATEX 1112 X
IP66 / IP68 (5 bar 30 min)

-40 °C - 75 °C

Prensa Cabo de Latão niquelado, Inserção de fixação Poliamida, Vedação de EPDM

EMSKE

Type	WISKA-No.	D (mm)	L (mm)	Ø (mm)	SW (mm)	TL (mm)	Box
EMSKE 12	10065040	M 12x1,5	5	4 · 7	16	23 · 30	50
EMSKE 16	10065041	M 16x1,5	5	5 · 10	20	26 · 34	50
EMSKE 20	10065042	M 20x1,5	6	6 · 13	24	29 · 37	50
EMSKE 25	10065043	M 25x1,5	7	10 · 17	29	33 · 42	50
EMSKE 32	10065044	M 32x1,5	8	13 · 21	36	36 · 44	25
EMSKE 40	10065045	M 40x1,5	8	16 · 28	46	44 · 55	10
EMSKE 50	10065046	M 50x1,5	9	21 · 35	55	51 · 62	10
EMSKE 63	10065047	M 63x1,5	10	34 · 48	68	56 · 67	10
EMSKE 75	10104386	M 75x1,5	12	48 · 62	82	67 · 81	1

EMSKE-L, longo

Type	WISKA-No.	D (mm)	L (mm)	Ø (mm)	SW (mm)	TL (mm)	Box
EMSKE-L 12	10065048	M 12x1,5	12	4 · 7	16	30 · 37	50
EMSKE-L 16	10065049	M 16x1,5	12	5 · 10	20	33 · 41	50
EMSKE-L 20	10065050	M 20x1,5	12	6 · 13	24	35 · 43	50
EMSKE-L 25	10065051	M 25x1,5	12	10 · 17	29	38 · 47	50
EMSKE-L 32	10065052	M 32x1,5	15	13 · 21	36	43 · 51	25
EMSKE-L 40	10065053	M 40x1,5	15	16 · 28	46	51 · 62	10
EMSKE-L 50	10065054	M 50x1,5	15	21 · 35	55	57 · 68	10
EMSKE-L 63	10065055	M 63x1,5	15	34 · 48	68	61 · 72	10

Acessórios Recomendados

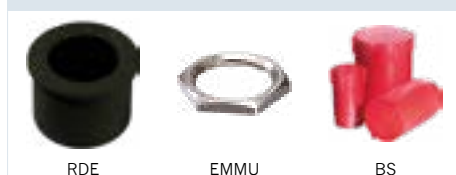

RDE

EMMU

BS

Prensa Cabo SPRINT® EX LowTemp, EMSKE LT, latão niquelado, métrico



EMSKE LT



EMSKE-L LT

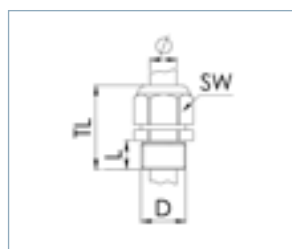

Marcação

Aprovação

Classe de proteção

Faixa de temperatura

Material

II 2 D Ex tb IIIC Db / II 2 G Ex eb IIC Gb

IECEx PTB 13.0027X / PTB 04 ATEX 1112 X

IP66 / IP68 (5 bar 30 min)

-60 °C - 75 °C

Prensa Cabo de Latão niquelado, Inserção de fixação Poliamida, Vedação de Silicone

EMSKE LT

Type	WISKA-No.					TL (mm)	
EMSKE 12 LT	10065946	M 12x1,5	5	4 · 7	16	23 · 30	50
EMSKE 16 LT	10065947	M 16x1,5	5	5 · 10	20	26 · 34	50
EMSKE 20 LT	10065948	M 20x1,5	6	6 · 13	24	29 · 37	50
EMSKE 25 LT	10065949	M 25x1,5	7	10 · 17	29	33 · 42	50
EMSKE 32 LT	10065950	M 32x1,5	8	13 · 21	36	36 · 44	25
EMSKE 40 LT	10065951	M 40x1,5	8	16 · 28	46	44 · 55	10
EMSKE 50 LT	10065952	M 50x1,5	9	21 · 35	55	51 · 62	10
EMSKE 63 LT	10065953	M 63x1,5	10	34 · 48	68	56 · 67	10

EMSKE-L LT, longo

Type	WISKA-No.					TL (mm)	
EMSKE-L 12 LT	10065938	M 12x1,5	12	4 · 7	16	30 · 37	50
EMSKE-L 16 LT	10065939	M 16x1,5	12	5 · 10	20	33 · 41	50
EMSKE-L 20 LT	10065940	M 20x1,5	12	6 · 13	24	35 · 43	50
EMSKE-L 25 LT	10065941	M 25x1,5	12	10 · 17	29	38 · 47	50
EMSKE-L 32 LT	10065942	M 32x1,5	15	13 · 21	36	43 · 51	25
EMSKE-L 40 LT	10065943	M 40x1,5	15	16 · 28	46	51 · 62	10
EMSKE-L 50 LT	10065944	M 50x1,5	15	21 · 35	55	57 · 68	10
EMSKE-L 63 LT	10065945	M 63x1,5	15	34 · 48	68	61 · 72	10

Acessórios Recomendados



EMMU

RDE LT

BS

Prensa Cabo SPRINT® EX, NMSKE, latão niquelado, NPT



NMSKE

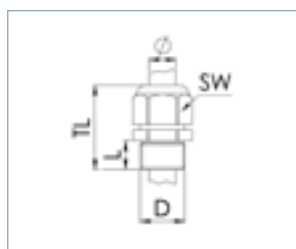

Marcação

Aprovação

Classe de proteção

Faixa de temperatura

Material

II 2 D Ex tb IIIC Db / II 2 G Ex eb IIC Gb

IECEX PTB 13.0027X / PTB 04 ATEX 1112 X

IP66 / IP68 (5 bar 30 min)

-40 °C - 75 °C

Prensa Cabo de Latão niquelado, Inserção de fixação Poliamida, Vedação de EPDM

Type	WISKA-No.	D (mm)	L (mm)	Ø (mm)	SW (mm)	TL (mm)	Box
NMSKE 1/4	10101082	NPT 1/4"	13	4 · 7	16	33 · 40	50
NMSKE 3/8	10101083	NPT 3/8"	13	5 · 10	20	35 · 42	50
NMSKE 1/2	10101084	NPT 1/2"	16	6 · 13	24	38 · 45	50
NMSKE 3/4	10101085	NPT 3/4"	16	10 · 17	29	40 · 48	50
NMSKE 1	10101086	NPT 1"	20	13 · 21	36	46 · 53	25
NMSKE 1 1/4	10101087	NPT 1 1/4"	20	16 · 28	46	50 · 58	10
NMSKE 1 1/2	10101088	NPT 1 1/2"	20	21 · 35	55	51 · 62	10
NMSKE 2	10101089	NPT 2"	21	34 · 48	68	56 · 67	10

Acessórios Recomendados



ADR

RDE

BS

NMMU

Pressa Cabo SPRINT® EX EMV com mola de contato, EMSKE EMV-S, latão, niquelado, métrico

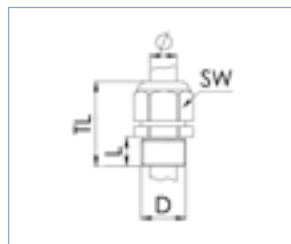
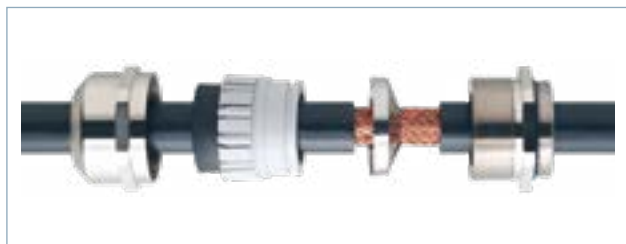

EMSKV EMV-S



Marcação

Aprovação

Classe de proteção

Faixa de temperatura

Material

II 2 D Ex tb IIIC Db / II 2 G Ex eb IIC Gb

IECEx PTB 13.0027X / PTB 04 ATEX 1112 X

IP66 / IP68 (5 bar 30 min)

-40 °C - 75 °C

Pressa Cabo de Latão niquelado, Inserção de fixação Poliamida, Inserção de mola de contacto: Aço inoxidável 1.4310, Vedação de EPDM

Type	WISKA-No.	D (mm)	L (mm)	(mm)	(mm)	SW (mm)	TL (mm)	
EMSKE 12 EMV-S	10102971	M 12x1,5	5	4 - 7	5	16	23 - 30	50
EMSKE 16 EMV-S	10102972	M 16x1,5	5	5 - 10	7,5	20	26 - 34	50
EMSKE 20 EMV-S	10102973	M 20x1,5	6	6 - 13	9,5	24	29 - 37	50
EMSKE 25 EMV-S	10102974	M 25x1,5	7	10 - 17	16	29	33 - 42	50
EMSKE 32 EMV-S	10102975	M 32x1,5	8	13 - 21	20	36	36 - 44	25
EMSKE 40 EMV-S	10102976	M 40x1,5	8	16 - 28	26	46	44 - 55	10
EMSKE 50 EMV-S	10102977	M 50x1,5	9	21 - 35	33	55	51 - 62	10
EMSKE 63 EMV-S	10102978	M 63x1,5	10	34 - 48	45	68	56 - 67	10

Accessórios Recomendados



RDE

EMMU-EMV

BS

Pressa Cabo SPRINT® EX EMC com cone de aterramento DIN 89345, EMSKE EMV-Z, latão niquelado, métrico

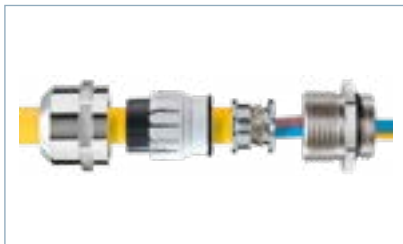

EMSKE EMV-Z

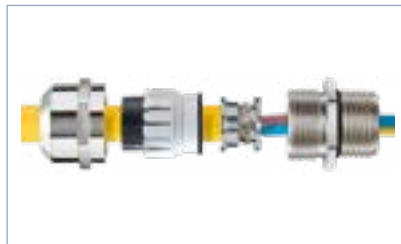

EMSKE-L EMV-Z

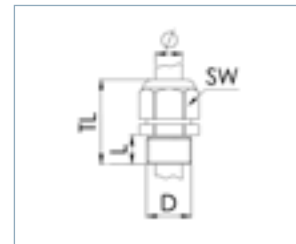

Marcação

Aprovação

Classe de proteção

Faixa de temperatura

Material

II 2 D Ex tb IIIC Db / II 2 G Ex eb IIC Gb

IECEx PTB 13.0027X / PTB 04 ATEX 1112 X

IP66 / IP68 (5 bar 30 min)

-40 °C - 75 °C

Pressa Cabo de Latão niquelado, Inserção de fixação Poliamida, Cones de aterramento: Latão cromado, Vedação de EPDM

EMSKE EMV-Z

Type	WISKA-No.	D (mm)	L (mm)	Ø (mm)	Ø (mm)	SW (mm)	TL (mm)	
EMSKE 12 EMV-Z	10065056	M 12x1,5	5	4 - 7	5	16	23 - 30	50
EMSKE 16 EMV-Z	10065057	M 16x1,5	5	5 - 10	7,5	20	26 - 34	50
EMSKE 20 EMV-Z	10065058	M 20x1,5	6	6 - 13	9,5	24	29 - 37	50
EMSKE 25 EMV-Z	10065059	M 25x1,5	7	10 - 17	16	29	33 - 42	50
EMSKE 32 EMV-Z	10065060	M 32x1,5	8	13 - 21	20	36	36 - 44	25
EMSKE 40 EMV-Z	10065061	M 40x1,5	8	16 - 28	26	46	44 - 55	10
EMSKE 50 EMV-Z	10065062	M 50x1,5	9	21 - 35	33	55	51 - 62	10
EMSKE 63 EMV-Z	10065063	M 63x1,5	10	34 - 48	45	68	56 - 67	10
EMSKE 75 EMV-Z	10104143	M 75x1,5	12	48 - 62	58	82	67 - 81	1

EMSKE-L EMV-Z, long

Type	WISKA-No.	D (mm)	L (mm)	Ø (mm)	Ø (mm)	SW (mm)	TL (mm)	
EMSKE-L 12 EMV-Z	10065922	M 12x1,5	12	4 - 7	5	16	30 - 37	50
EMSKE-L 16 EMV-Z	10065923	M 16x1,5	12	5 - 10	7,5	20	33 - 41	50
EMSKE-L 20 EMV-Z	10065924	M 20x1,5	12	6 - 13	9,5	24	35 - 43	50
EMSKE-L 25 EMV-Z	10065925	M 25x1,5	12	10 - 17	16	29	38 - 47	50
EMSKE-L 32 EMV-Z	10065926	M 32x1,5	15	13 - 21	20	36	43 - 51	25
EMSKE-L 40 EMV-Z	10065927	M 40x1,5	15	16 - 28	26	46	51 - 62	10
EMSKE-L 50 EMV-Z	10065928	M 50x1,5	15	21 - 35	33	55	57 - 68	10
EMSKE-L 63 EMV-Z	10065929	M 63x1,5	15	34 - 48	45	68	61 - 72	10

Acessórios Recomendados



RDE

EMMU-EMV

BS

Pressa Cabo SPRINT® EX com alívio de tensão externo, EMSKEZ, latão niquelado, métrico

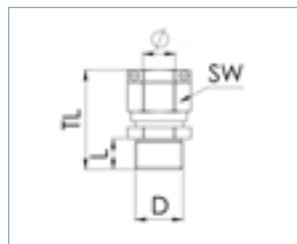

EMSKEZ



SPRINT



Marcação

Aprovação

Classe de proteção

Faixa de temperatura

Material

II 2 D Ex tb IIIC Db / II 2 G Ex eb IIC Gb

IECEx PTB 13.0052X / PTB 09 ATEX 1049 X

IP68 (5 bar 30 min)

-40 °C - 75 °C

Pressa Cabo de Latão niquelado, Inserção de fixação Poliamida, Vedação de EPDM

Type	WISKA-No.					TL (mm)	
EMSKEZ 16	10063071	M 16x1,5	5	6,5 - 10	20	36 - 44	25
EMSKEZ 20	10063072	M 20x1,5	6	8 - 13	24	39 - 47	25
EMSKEZ 25	10063073	M 25x1,5	7	10 - 17	29	43 - 52	25
EMSKEZ 32	10063074	M 32x1,5	8	16 - 21	36	46 - 54	25
EMSKEZ 40	10063075	M 40x1,5	8	18 - 28	46	54 - 65	10
EMSKEZ 50	10063076	M 50x1,5	9	22 - 35	55	61 - 72	10
EMSKEZ 63	10063077	M 63x1,5	10	35 - 48	68	66 - 77	10

Acessórios Recomendados



RDE

EMMU

BS

Bujão EX, EX-EMVS, latão niquelado, métrico

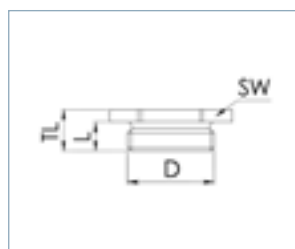

EX-EMVS



Marcação

Aprovação

Classe de proteção

Faixa de temperatura

Material

II 2 D Ex tb IIIC Db / II 2 G Ex e IIC Gb

IECEX PTB 14.0024 / PTB 05 ATEX 1106

IP66 / IP68 (5 bar 30 min)

-40° C - 120 °C

Latão, niquelado, Vedação de EPDM

Type	WISKA-No. Niquelado	D (mm)	L (mm)	SW (mm)	TL (mm)	
EX-EMVS 12	10065331	M 12x1,5	5	14	7,5	10
EX-EMVS 16	10065332	M 16x1,5	5	18	8	10
EX-EMVS 20	10065333	M 20x1,5	6	22	9	10
EX-EMVS 25	10065334	M 25x1,5	6,5	28	10	10
EX-EMVS 32	10065335	M 32x1,5	7	35	10,5	5
EX-EMVS 40	10065336	M 40x1,5	8	44	12	5
EX-EMVS 50	10065337	M 50x1,5	9	54	15	1
EX-EMVS 63	10065338	M 63x1,5	10	67	16	1

Acessórios Recomendados



EMMU

PLÁSTICO

METAL

MARÍTIMO

EMC

EX E/I

EX D

FERROVIÁRIO

EQUILIBRAÇÃO /
VENTILAÇÃOPADRÃO
BRITÂNICO

VEDAÇÕES

MEMBRANA

CONMAXX

CONMAXX
GLANDBRACE
FITTING
PLÁSTICOBRACE
CONDUIT
PLÁSTICOBRACE
FITTING
METALBRACE
CONDUIT
METAL

Prensa Cabo SPRINT® EX, ESSKE, aço inoxidável, métrico



ESSKE



ESSKE-4

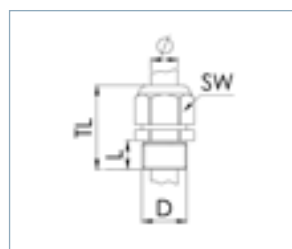

Marcação

Aprovação

Classe de proteção

Faixa de temperatura

Material

II 2 D Ex tb IIIC Db / II 2 G Ex eb IIC Gb

IECEx PTB 13.0035X / PTB 05 ATEX 1098 X

IP66 / IP68 (5 bar 30 min)

-40 °C - 75 °C

Prensa Cabo de Aço inoxidável A2 (1.4305), Inserção de fixação Poliamida, Vedação de EPDM

ESSKE, aço inoxidável 1.4305

Type	WISKA-No.					TL (mm)	
ESSKE 12	10069200	M 12x1,5	5	4 · 7	17	23 · 30	10
ESSKE 16	10069201	M 16x1,5	5	5 · 10	22	26 · 34	10
ESSKE 20	10069202	M 20x1,5	6	6 · 13	24	29 · 37	10
ESSKE 25	10069203	M 25x1,5	7	10 · 17	30	33 · 42	10
ESSKE 32	10069204	M 32x1,5	8	13 · 21	36	36 · 44	5
ESSKE 40	10069205	M 40x1,5	8	16 · 28	46	44 · 55	5
ESSKE 50	10069206	M 50x1,5	9	21 · 35	55	51 · 62	2
ESSKE 63	10069207	M 63x1,5	10	34 · 48	68	56 · 67	1

ESSKE-4, aço inoxidável 1.4404

Type	WISKA-No.					TL (mm)	
ESSKE-4 12	10069232	M 12x1,5	5	4 · 7	17	23 · 30	10
ESSKE-4 16	10069233	M 16x1,5	5	5 · 10	22	26 · 34	10
ESSKE-4 20	10069234	M 20x1,5	6	6 · 13	24	29 · 37	10
ESSKE-4 25	10069235	M 25x1,5	7	10 · 17	30	33 · 42	10
ESSKE-4 32	10069236	M 32x1,5	8	13 · 21	36	36 · 44	5
ESSKE-4 40	10069237	M 40x1,5	8	16 · 28	46	44 · 55	5
ESSKE-4 50	10069238	M 50x1,5	9	21 · 35	55	51 · 62	2
ESSKE-4 63	10069239	M 63x1,5	10	34 · 48	68	56 · 67	1

Acessórios Recomendados



RDE

BS

ESMU

Pressa Cabo SPRINT® EX EMC com cone de aterramento DIN 89345, ESSKE EMV-Z, aço inoxidável, métrico



ESSKE EMV-Z

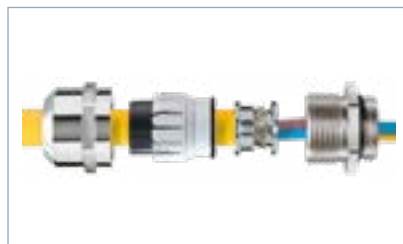

ESSKE-4 EMV-Z

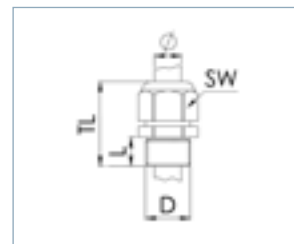

Marcação

Aprovação

Classe de proteção

Faixa de temperatura

Material

II 2 D Ex tb IIIC Db / II 2 G Ex eb IIC Gb
 IECEx PTB 13.0035X / PTB 05 ATEX 1098 X
 IP66 / IP68 (5 bar 30 min)
 -40 °C - 75 °C
 Pressa Cabo de Aço inoxidável A2 (1.4305), Inserção de fixação Poliamida,
 Vedação de EPDM

ESSKE EMV-Z, aço inoxidável 1.4305

Type	WISKA-No.						TL (mm)	
ESSKE 12 EMV-Z	10069216	M 12x1,5	5	4 · 7	5	17	23 · 30	10
ESSKE 16 EMV-Z	10069217	M 16x1,5	5	5 · 10	7,5	22	26 · 34	10
ESSKE 20 EMV-Z	10069218	M 20x1,5	6	6 · 13	9,5	24	29 · 37	10
ESSKE 25 EMV-Z	10069219	M 25x1,5	7	10 · 17	16	30	33 · 42	10
ESSKE 32 EMV-Z	10069220	M 32x1,5	8	13 · 21	20	36	36 · 44	5
ESSKE 40 EMV-Z	10069221	M 40x1,5	8	16 · 28	26	46	44 · 55	5
ESSKE 50 EMV-Z	10069222	M 50x1,5	9	21 · 35	33	55	51 · 62	2
ESSKE 63 EMV-Z	10069223	M 63x1,5	10	34 · 48	45	68	56 · 67	1

ESSKE-4 EMV-Z, aço inoxidável 1.4404

Type	WISKA-No.						TL (mm)	
ESSKE-4 12 EMV-Z	10069248	M 12x1,5	5	4 · 7	5	17	23 · 30	10
ESSKE-4 16 EMV-Z	10069249	M 16x1,5	5	5 · 10	7,5	22	26 · 34	10
ESSKE-4 20 EMV-Z	10069250	M 20x1,5	6	6 · 13	9,5	24	29 · 37	10
ESSKE-4 25 EMV-Z	10069251	M 25x1,5	7	10 · 17	16	30	33 · 42	10
ESSKE-4 32 EMV-Z	10069252	M 32x1,5	8	13 · 21	20	36	36 · 44	5
ESSKE-4 40 EMV-Z	10069253	M 40x1,5	8	16 · 28	26	46	44 · 55	5
ESSKE-4 50 EMV-Z	10069254	M 50x1,5	9	21 · 35	33	55	51 · 62	2
ESSKE-4 63 EMV-Z	10069255	M 63x1,5	10	34 · 48	45	68	56 · 67	1

Acessórios Recomendados



RDE

BS

ESMU

Prensa Cabo EX d OS-A2F-U para cabos não blindados, latão níquelado, métrico



OS-A2F-U

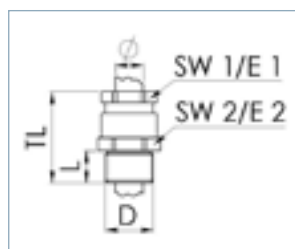

Marcação

Aprovação

Classe de proteção

Faixa de temperatura

Material







III 2 D Ex tb IIIC Db, II 2 G Ex db IIC Gb, II 2 G Ex eb IIC Gb

IECEx PRE 17.0062X / Presafe 17 ATEX 11454 X

IP66 / IP67

-60° C - 110° C

Latão níquelado, Vedação de Silicone

Type	WISKA-No. Niquelado	 D (mm)	 L (mm)	 (mm)	 SW 1 (mm)	 SW 2 (mm)	
OS-A2F-U 16 / M16	50107568	M 16x1,5	15	3 - 7	19	24	1
OS-A2F-U 16X / M16	50107569	M 16x1,5	15	5 - 10,3	19	24	1
OS-A2F-U 20 / M20	50107570	M 20x1,5	15	9 - 15,3	24	27	1
OS-A2F-U 25 / M25	50107571	M 25x1,5	15	13 - 20	28	32	1
OS-A2F-U 32 / M32	50107572	M 32x1,5	15	17 - 26,5	34	39	1
OS-A2F-U 40 / M40	50107573	M 40x1,5	15	22 - 32	42	48	1
OS-A2F-U 50 / M50	50107574	M 50x1,5	15	30 - 42	53	58	1
OS-A2F-U 63 / M63	50107575	M 63x1,5	15	39 - 51	68	73	1
OS-A2F-U 63X / M63	50107576	M 63x1,5	15	46 - 55	68	73	1
OS-A2F-U 75 / M75	50107577	M 75x1,5	20	54 - 61	78	85	1
OS-A2F-U 75X / M75	50107578	M 75x1,5	20	58 - 68	78	85	1

Prensa Cabo EX d OS-E1UF para cabos blindados, latão niquelado, métrico



OS-E1UF

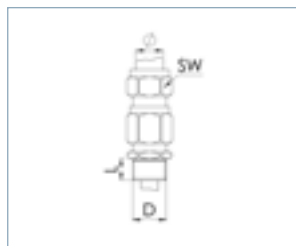

Marcação

Aprovação

Classe de proteção

Faixa de temperatura

Material

III 2 D Ex tb IIIC Db, II 2 G Ex db IIC Gb, II 2 G Ex eb IIC Gb

IECEx PRE 17.0063X / Presafe 17 ATEX 11456 X

IP66 / IP67

-60° C - 110° C

Prensa Cabo de Latão niquelado, Vedação de Silicone

Type	WISKA-No. Niquelado						
OS-E1UF-U 16 / M16	50107579	M 16x1,5	15	7 · 16,1	5 · 11,5	25	1
OS-E1UF-U 20 / M20	50107580	M 20x1,5	15	12 · 21	7,5 · 15,2	31	1
OS-E1UF-U 25 / M25	50107581	M 25x1,5	15	17 · 26,2	13 · 19,6	37	1
OS-E1UF-U 32 / M32	50107582	M 32x1,5	15	22 · 34	16,5 · 26,2	47	1
OS-E1UF-U 40 / M40	50107583	M 40x1,5	15	30 · 42	23 · 32,3	56	1
OS-E1UF-U 50 / M50	50107584	M 50x1,5	15	38 · 53,7	29 · 41,5	70	1
OS-E1UF-U 63 / M63	50107585	M 63x1,5	15	45 · 60	39 · 50	77	1
OS-E1UF-U 63X / M63	50107586	M 63x1,5	15	52 · 66	46 · 55	82	1
OS-E1UF-U 75 / M75	50107587	M 75x1,5	20	58 · 72	52 · 61	92	1
OS-E1UF-U 75X / M75	50107588	M 75x1,5	20	66,1 · 79	59 · 67	98	1

Bujão EX d stop, OSSP, latão niquelado, métrico

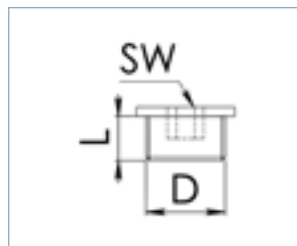

OSSP

Marcação
Aprovação
Classe de proteção
Faixa de temperatura
Material

III 2 D Ex tb IIIC Db, II 2 G Ex db IIC Gb, II 2 G Ex eb IIC Gb

IECEx PRE 15.0019X / Presafe 16 ATEX 7985X

IP66 / IP67

-60 °C - 120 °C

Latão, niquelado, Vedação de CR

Type	WISKA-No. Niquelado				
OSSP-R 16	50065610	M 16x1,5	15	10	1
OSSP-R 20	50065611	M 20x1,5	15	10	1
OSSP-R 25	50065612	M 25x1,5	15	10	1
OSSP-R 32	50065613	M 32x1,5	15	10	1
OSSP-R 40	50065614	M 40x1,5	15	10	1
OSSP-R 50	50065615	M 50x1,5	15	10	1
OSSP-R 63	50065616	M 63x1,5	15	10	1
OSSP-R 75	50065617	M 75x1,5	15	10	1

Redução de rosca EX d, OSRA, latão niquelado, métrico-métrico



OSRA

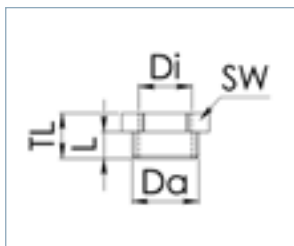

Marcação
Aprovação
Classe de proteção
Material

III 2 D Ex tb IIIC Db, II 2 G Ex db IIC Gb, II 2 G Ex eb IIC Gb
IECEx PRE 15.0019X / Presafe 16 ATEX 7985X
IP66 / IP67
Latão, niquelado

Type	WISKA-No. Niquelado	Da (mm)	Di (mm)	SW (mm)	
OSRA 20-16	50065650	M 20x1,5	M 16x1,5	25	1
OSRA 25-16	50065651	M 25x1,5	M 16x1,5	30	1
OSRA 25-20	50065652	M 25x1,5	M 20x1,5	30	1
OSRA 32-16	50065653	M 32x1,5	M 16x1,5	38	1
OSRA 32-20	50065654	M 32x1,5	M 20x1,5	38	1
OSRA 32-25	50065655	M 32x1,5	M 25x1,5	38	1
OSRA 40-20	50065656	M 40x1,5	M 20x1,5	45	1
OSRA 40-25	50065657	M 40x1,5	M 25x1,5	45	1
OSRA 40-32	50065658	M 40x1,5	M 32x1,5	45	1
OSRA 50-25	50065659	M 50x1,5	M 25x1,5	55	1
OSRA 50-32	50065660	M 50x1,5	M 32x1,5	55	1
OSRA 50-40	50065661	M 50x1,5	M 40x1,5	55	1
OSRA 63-32	50065662	M 63x1,5	M 32x1,5	68	1
OSRA 63-40	50065663	M 63x1,5	M 40x1,5	68	1
OSRA 63-50	50065664	M 63x1,5	M 50x1,5	68	1
OSRA 75-40	50065665	M 75x1,5	M 40x1,5	82	1
OSRA 75-50	50065666	M 75x1,5	M 50x1,5	82	1
OSRA 75-63	50065667	M 75x1,5	M 63x1,5	82	1

Adaptadores de ampliação de rosca EX d, OSAJ, latão níquelado, métrico-métrico



OSAJ

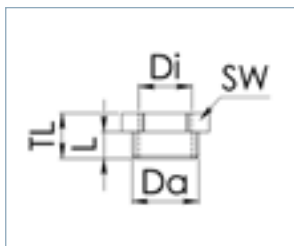

Marcação
Aprovação
Classe de proteção
Material

III 2 D Ex tb IIIC Db, II 2 G Ex db IIC Gb, II 2 G Ex eb IIC Gb
IECEx PRE 15.0019X / Presafe 16 ATEX 7985X
IP66 / IP67
Latão, níquelado

Type	WISKA-No. Níquelado	Da (mm)	Di (mm)	SW (mm)	
OSAJ 16/20	50065686	M 16x1,5	M 20x1,5	25	1
OSAJ 16/25	50065687	M 16x1,5	M 25x1,5	30	1
OSAJ 20/25	50065688	M 20x1,5	M 25x1,5	30	1
OSAJ 16/32	50065689	M 16x1,5	M 32x1,5	37	1
OSAJ 20/32	50065690	M 20x1,5	M 32x1,5	37	1
OSAJ 25/32	50065691	M 25x1,5	M 32x1,5	37	1
OSAJ 20/40	50065692	M 20x1,5	M 40x1,5	46	1
OSAJ 25/40	50065693	M 25x1,5	M 40x1,5	46	1
OSAJ 32/40	50065694	M 32x1,5	M 40x1,5	46	1
OSAJ 25/50	50065695	M 25x1,5	M 50x1,5	57	1
OSAJ 32/50	50065696	M 32x1,5	M 50x1,5	57	1
OSAJ 40/50	50065697	M 40x1,5	M 50x1,5	57	1
OSAJ 32/63	50065698	M 32x1,5	M 63x1,5	70	1
OSAJ 40/63	50065699	M 40x1,5	M 63x1,5	70	1
OSAJ 50/63	50065700	M 50x1,5	M 63x1,5	70	1
OSAJ 40/75	50065701	M 40x1,5	M 75x1,5	82	1
OSAJ 50/75	50065702	M 50x1,5	M 75x1,5	82	1
OSAJ 63/75	50065703	M 63x1,5	M 75x1,5	82	1

Anel de aterramento, OSET, latão





OSET



Material

Latão, niquelado

Type	WISKA-No.		
OSET 16	50065634	M 16	1
OSET 20	50065635	M 20	1
OSET 25	50065636	M 25	1
OSET 32	50065637	M 32	1
OSET 40	50065638	M 40	1
OSET 50	50065639	M 50	1
OSET 63	50065640	M 63	1
OSET 75	50065641	M 75	1

PLÁSTICO

METAL

MARÍTIMO

EMC

EX E/I

EX D

FERROVIÁRIO

EQUILIBRAÇÃO /
VENTILAÇÃOPADRÃO
BRITÂNICO

VEDAÇÕES

MEMBRANA

CONMAXX

CONMAXX
GLANDBRACE
FITTING
PLÁSTICOBRACE
CONDUIT
PLÁSTICOBRACE
FITTING
METALBRACE
CONDUIT
METAL

Capas de Proteção, OSSH, poliamida





OSSH





Material

CR

OSSH-A, tipo A

Type	WISKA-No.		
OSSH-A-16	50065626	OS-E1UF-U 16	1
OSSH-A-20	50065627	OS-E1UF-U 20	1
OSSH-A-25	50065628	OS-E1UF-U 25	1
OSSH-A-32	50065629	OS-E1UF-U 32	1
OSSH-A-40	50065630	OS-E1UF-U 40	1
OSSH-A-50	50065631	OS-E1UF-U 50	1
OSSH-A-63	50065632	OS-E1UF-U 63	1
OSSH-A-75	50065633	OS-E1UF-U 75	1

OSSH-B, tipo B

Type	WISKA-No.		
OSSH-B-16	50065642	OS-A2F-U 16	1
OSSH-B-20	50065643	OS-A2F-U 20	1
OSSH-B-25	50065644	OS-A2F-U 25	1
OSSH-B-32	50065645	OS-A2F-U 32	1
OSSH-B-40	50065646	OS-A2F-U 40	1
OSSH-B-50	50065647	OS-A2F-U 50	1
OSSH-B-63	50065648	OS-A2F-U 63	1



Prensa Cabo Ferroviário - Railway

Especialmente para o setor ferroviário, oferecemos a nossa própria série com vedações para uso ferroviária. Eles correspondem à alta qualidade e Requisitos de segurança da norma europeia de segurança contra incêndios EN 45545 e alcança o nível de perigo mais alto, o Nível de Risco 3. Nossos prensa cabos são feitos de plástico, latão ou aço inoxidável. Além disso, podem ser usados modularmente com seus acessórios.



Feito para trilhos, a nossa série para Ferrovias.

Uma extensão do sistema já comprovado da linha de prensa cabos SPRINT®, que atende as necessidades especiais da indústria ferroviária em todos os aspectos.

Desde junho de 2013, produtos e materiais utilizados no transporte ferroviário, foram testados de acordo com a norma europeia unificada de segurança contra incêndios EN 45545. Depois de vários anos de trabalho e de pesquisas e desenvolvimento lançamos uma linha de produtos inovadora, com todos os padrões exigidos de qualidade e segurança, alcançamos o Nível 3 de perigo, o mais alto nível do setor ferroviário.

Somos também um dos primeiros fabricantes da Europa com uma série completa testada com sucesso nos Materiais de latão, poliamida e aço inoxidável de acordo com EN 45545. Estes são os nossos prensa cabos para ferrovia, são a combinação ideal de produto da mais alta qualidade e modularidade múltipla com conformidade simultânea. Pode ser usado por fabricantes, fornecedores e empresas de tecnologia ferroviária irrestrito em todos os tipos de veículos idenpendente de ser veículos novos, de inspeção ou que estejam sendo reparados.

Uso mais inovador de materiais.

Uso de material mais inovador e de extensos testes de material, a WISKA testou o comportamento ao fogo dos materiais e das matérias-primas de acordo com norma EN 45545-2 para obter os melhores resultados possíveis, assim obter uma composição da série de prensa cabos para Ferrovias - Railway de alto desempenho.

Como parte do extenso teste de materiais, testamos o comportamento ao fogo os materiais e matérias-primas de acordo com EN 45545-2. Testamos uma ampla variedade de materiais para garantir uma ótima composição dessa série para aplicação no setor ferroviário.

Para os conjuntos de requisitos R22 (uso interno) e R23 (uso externo) foram testado os seguintes parâmetros de materiais inflamáveis (plástico, material vedante):

Conformidades	Parâmetros	Unidade medida	Requisitos	HL1	HL2	HL3
R22	índice de oxigênio	Vol.-%	Mínima	28	28	32
	Densidade do fumo	D _s max.	Máximo	600	300	150
	Toxicidade	CIT _{NLP}	Máximo	1,2	0,9	0,75
R23	índice de oxigênio	Vol.-%	Mínima	28	28	32
	Densidade do fumo	D _s max.	Máximo	...	600	300
	Toxicidade	CIT _{NLP}	Máximo	...	1,8	1,5

Pressa Cabo Ferroviário - Railway SPRINT®, ESKV RW, poliamida, métrica, EN 45545

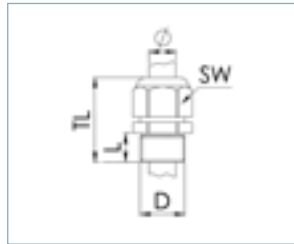

ESKV RW



Classe de proteção IP68 (5 bar 30 min) / IP69
Faixa de temperatura -40 °C - 100 °C
Nível de perigo EN gem. 45545 R22=HL3 / R23=HL3 / R24=HL3
Material Pressa Cabo de Poliamida UL94-V0, Vedação de EPDM

Type	WISKA-No. RAL 7035	WISKA-No. RAL 9005					TL (mm)	
ESKV 12 RW	10105492	10105810	M 12x1,5	9	3 - 7	16	29 - 34	50
ESKV 16 RW	10105493	10105811	M 16x1,5	9	4,5 - 10	20	31 - 37	50
ESKV 20 RW	10105494	10105812	M 20x1,5	10	6 - 13	24	36 - 45	50
ESKV 25 RW	10105495	10105813	M 25x1,5	10	9 - 17	29	38 - 47	50
ESKV 32 RW	10105496	10105814	M 32x1,5	12	13 - 21	36	42 - 51	25
ESKV 40 RW	10105497	10105815	M 40x1,5	12	16 - 28	46	52 - 65	10
ESKV 50 RW	10105498	10105816	M 50x1,5	14	21 - 35	55	59 - 72	4
ESKV 63 RW	10105499	10105817	M 63x1,5	15	34 - 48	68	64 - 78	3

Acessórios Recomendados



EMUF

EADR

BS

RDE RW

MFD RW

Pressa Cabo Ferroviário - Railway SPRINT®, EMSKV RW, latão níquelado, métrico, EN 45545



EMSKV RW



EMSKV-L RW

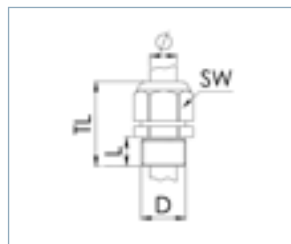

Classe de proteção IP68 (5 bar 30 min) / IP69
Faixa de temperatura -40 °C - 100 °C
Nível de perigo EN gem. 45545 R22=HL3 / R23=HL3 / R24=HL3
Material Pressa Cabo de Latão níquelado, Inserção de fixação Poliamida UL94-V0, Vedação de EPDM

EMSKV RW

Type	WISKA-No.	D (mm)	L (mm)	Ø (mm)	SW (mm)	TL (mm)	
EMSKV 12 RW	10104293	M 12x1,5	5	3 - 7	16	23 - 30	50
EMSKV 16 RW	10104294	M 16x1,5	5	4,5 - 10	20	26 - 34	50
EMSKV 20 RW	10104296	M 20x1,5	6	6 - 13	24	29 - 37	50
EMSKV 25 RW	10104297	M 25x1,5	7	9 - 17	29	33 - 42	50
EMSKV 32 RW	10104298	M 32x1,5	8	13 - 21	36	36 - 44	25
EMSKV 40 RW	10104299	M 40x1,5	8	16 - 28	46	44 - 55	10
EMSKV 50 RW	10104300	M 50x1,5	9	21 - 35	55	51 - 62	10
EMSKV 63 RW	10104301	M 63x1,5	10	34 - 48	68	56 - 67	10
EMSKV 75 RW	10104302	M 75x1,5	12	48 - 62	82	67 - 81	1

EMSKV-L RW, longo

Type	WISKA-No.	D (mm)	L (mm)	Ø (mm)	SW (mm)	TL (mm)	
EMSKV-L 12 RW	10106174	M 12x1,5	12	3 - 7	16	30 - 37	50
EMSKV-L 16 RW	10106175	M 16x1,5	12	4,5 - 10	20	33 - 41	50
EMSKV-L 20 RW	10106176	M 20x1,5	12	6 - 13	24	35 - 43	50
EMSKV-L 25 RW	10106177	M 25x1,5	12	9 - 17	29	38 - 47	50
EMSKV-L 32 RW	10106178	M 32x1,5	15	13 - 21	36	43 - 51	25
EMSKV-L 40 RW	10106179	M 40x1,5	15	16 - 28	46	51 - 62	10
EMSKV-L 50 RW	10106180	M 50x1,5	15	21 - 35	55	57 - 68	10
EMSKV-L 63 RW	10106181	M 63x1,5	15	34 - 48	68	61 - 72	10

Acessórios Recomendados



Pressa Cabo Ferroviário - Railway SPRINT® Baixa Temperatura, EMSKV LT RW, latão niquelado, métrico, EN 45545



EMSKV LT RW

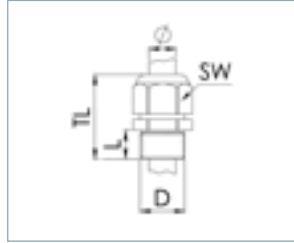

Classe de proteção IP68 (5 bar 30 min) / IP69
Faixa de temperatura -60 °C - 100 °C
Nível de perigo EN gem. 45545 R22=HL3 / R23=HL3 / R24=HL3
Material Pressa Cabo de Latão niquelado, Inserção de fixação Poliamida UL94-V0, Vedação de Silicone

Type	WISKA-No.	D (mm)	(mm)	(mm)	SW (mm)	TL (mm)	
EMSKV 12 LT RW	10105823	M 12x1,5	5	3 - 7	16	23 - 30	50
EMSKV 16 LT RW	10105824	M 16x1,5	5	4,5 - 10	20	26 - 34	50
EMSKV 20 LT RW	10105825	M 20x1,5	6	6 - 13	24	29 - 37	50
EMSKV 25 LT RW	10105826	M 25x1,5	7	9 - 17	29	33 - 42	50
EMSKV 32 LT RW	10105827	M 32x1,5	8	13 - 21	36	36 - 44	25
EMSKV 40 LT RW	10105828	M 40x1,5	8	16 - 28	46	44 - 55	10

Acessórios Recomendados



EMMU

RDE LT

BS

ORD-S

PLÁSTICO
METAL
MARÍTIMO
EMC
EX E/I
EX D
FERROVIÁRIO
EQUILIBRAÇÃO / VENTILAÇÃO
PADRÃO BRITÂNICO
VEDAÇÕES
MEMBRANA
CONMAXX
CONMAXX GLAND
BRACE FITTING PLÁSTICO
BRACE CONDUIT PLÁSTICO
BRACE FITTING METAL
BRACE CONDUIT METAL

Pressa Cabo Ferroviário - Railway SPRINT® EMC com cone de aterramento DIN 89345, EMSKV EMV-Z RW, latão niquelado, métrico, EN 45545

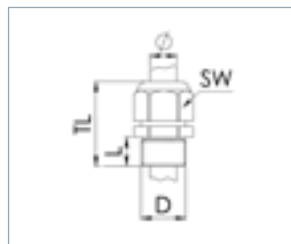

EMSKV EMV-Z RW



Classe de proteção IP68 (5 bar 30 min) / IP69
Faixa de temperatura -40 °C - 100 °C
Nível de perigo EN gem. 45545 R22=HL3 / R23=HL3 / R24=HL3
Material Pressa Cabo de Latão niquelado, Inserção de fixação Poliamida UL94-V0, Cones de aterramento: Latão cromado, Vedação de EPDM

Type	WISKA-No.						TL (mm)	
EMSKV 12 EMV-Z RW	10104303	M 12x1,5	5	3 - 7	5	16	23 - 30	50
EMSKV 16 EMV-Z RW	10104304	M 16x1,5	5	4,5 - 10	7,5	20	26 - 34	50
EMSKV 20 EMV-Z RW	10104305	M 20x1,5	6	6 - 13	9,5	24	29 - 37	50
EMSKV 25 EMV-Z RW	10104306	M 25x1,5	7	9 - 17	16	29	33 - 42	50
EMSKV 32 EMV-Z RW	10104307	M 32x1,5	8	13 - 21	20	36	36 - 44	25
EMSKV 40 EMV-Z RW	10104309	M 40x1,5	8	16 - 28	26	46	44 - 55	10
EMSKV 50 EMV-Z RW	10104308	M 50x1,5	9	21 - 35	33	55	51 - 62	10
EMSKV 63 EMV-Z RW	10104310	M 63x1,5	10	34 - 48	45	68	56 - 67	10
EMSKV 75 EMV-Z RW	10104311	M 75x1,5	12	48 - 63	58	82	67 - 81	1

Acessórios Recomendados



Pressa Cabo Ferroviário - Railway SPRINT® EMC Baixa Temperatura LowTemp com cone de aterramento DIN 89345, EMSKV LT EMV-Z RW, latão níquelado, métrico, EN 45545

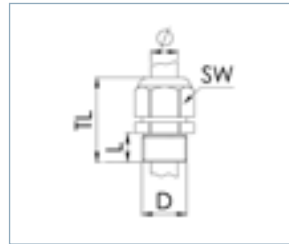

EMSKV LT EMV-Z RW



Classe de proteção IP68 (5 bar 30 min) / IP69
Faixa de temperatura -60 °C - 100 °C
Nível de perigo EN gem. 45545 R22=HL3 / R23=HL3 / R24=HL3
Material Pressa Cabo de Latão níquelado, Inserção de fixação Poliamida UL94-V0, Cones de aterramento: Latão cromado, Vedação de Silicone

Type	WISKA-No.						TL (mm)	
EMSKV 12 LT EMV-Z RW	10105848	M 12x1,5	5	3 - 7	5	16	23 - 30	50
EMSKV 16 LT EMV-Z RW	10105849	M 16x1,5	5	4,5 - 10	7,5	20	26 - 34	50
EMSKV 20 LT EMV-Z RW	10105850	M 20x1,5	6	6 - 13	9,5	24	29 - 37	50
EMSKV 25 LT EMV-Z RW	10105851	M 25x1,5	7	9 - 17	16	29	33 - 42	50
EMSKV 32 LT EMV-Z RW	10105852	M 32x1,5	8	13 - 21	20	36	36 - 44	25
EMSKV 40 LT EMV-Z RW	10105853	M 40x1,5	8	16 - 28	26	46	44 - 55	10

Acessórios Recomendados



EMMU

RDE LT

BS

ORD-S

PLÁSTICO
METAL
MARÍTIMO
EMC
EX E/I
EX D
FERROVIÁRIO
EQUILIBRAÇÃO / VENTILAÇÃO
PADRÃO BRITÂNICO
VEDAÇÕES
MEMBRANA
CONMAXX
CONMAXX GLAND
BRACE FITTING PLÁSTICO
BRACE CONDUIT PLÁSTICO
BRACE FITTING METAL
BRACE CONDUIT METAL

Pressa Cabos Ferroviário railway SPRINT®, ESKV RW, aço inoxidável, métrico, EN 45545

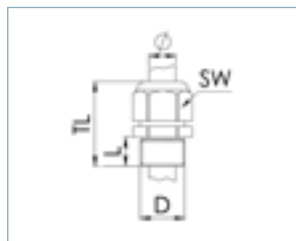

ESKV RW



Classe de proteção IP68 (5 bar 30 min) / IP69
Faixa de temperatura -40 °C - 100 °C
Nível de perigo EN gem. 45545 R22=HL3 / R23=HL3 / R24=HL3
Material Pressa Cabo de Aço inoxidável A2 (1.4305), Inserção de fixação Poliamida UL94-V0, Vedação de EPDM

Type	WISKA-No.					TL [mm]	
ESKV 12 RW	10105832	M 12x1,5	5	3 - 7	17	23 - 30	10
ESKV 16 RW	10105833	M 16x1,5	5	4,5 - 10	22	26 - 34	10
ESKV 20 RW	10105834	M 20x1,5	6	6 - 13	24	29 - 37	10
ESKV 25 RW	10105835	M 25x1,5	7	9 - 17	30	33 - 42	10
ESKV 32 RW	10105836	M 32x1,5	8	13 - 21	36	36 - 44	5
ESKV 40 RW	10105837	M 40x1,5	8	16 - 28	46	44 - 55	5
ESKV 50 RW	10105838	M 50x1,5	9	21 - 35	55	51 - 62	2
ESKV 63 RW	10105839	M 63x1,5	10	34 - 48	68	56 - 67	1

Accessórios Recomendados



BS

ESMU

RDE RW

MFD RW

Pressa Cabo Ferroviário - Railway SPRINT® Baixa Temperatura LowTemp, ESSKV LT RW, aço inoxidável, métrico, EN 45545



ESSKV LT RW

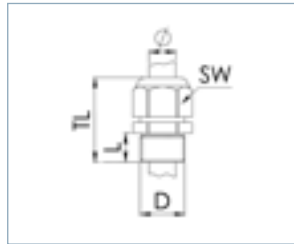

Classe de proteção IP68 (5 bar 30 min) / IP69
Faixa de temperatura -60 °C - 100 °C
Nível de perigo EN gem. 45545 R22=HL3 / R23=HL3 / R24=HL3
Material Pressa Cabo de Aço inoxidável A2 (1.4305), Inserção de fixação Poliamida UL94-V0, Vedação de Silicone

Type	WISKA-No.	D [mm]	TL [mm]	SW [mm]	TL [mm]	
ESSKV 12 LT RW	10105840	M 12x1,5	5	3 - 7	17	10
ESSKV 16 LT RW	10105841	M 16x1,5	5	4,5 - 10	22	10
ESSKV 20 LT RW	10105842	M 20x1,5	6	6 - 13	24	10
ESSKV 25 LT RW	10105843	M 25x1,5	7	9 - 17	30	10
ESSKV 32 LT RW	10105844	M 32x1,5	8	13 - 21	36	5
ESSKV 40 LT RW	10105845	M 40x1,5	8	16 - 28	46	5

Acessórios Recomendados



RDE LT

BS

ESMU

ORD-S

PLÁSTICO
 METAL
 MARÍTIMO
 EMC
 EX E/I
 EX D
 FERROVIÁRIO
 EQUALIZAÇÃO / VENTILAÇÃO
 PADRÃO BRITÂNICO
 VEDAÇÕES
 MEMBRANA
 CONMAXX
 CONMAXX GLAND
 BRACE FITTING PLÁSTICO
 BRACE CONDUIT PLÁSTICO
 BRACE FITTING METAL
 BRACE CONDUIT METAL

Pressa Cabo Ferroviário - Railway SPRINT® EMC com cone de aterramento DIN 89345, ESKV EMV-Z RW, aço inoxidável, métrico, EN 45545

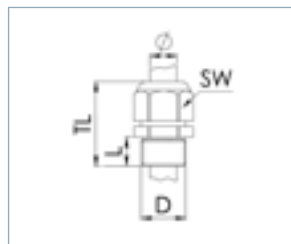

ESSKV EMV-Z RW



Classe de proteção IP68 (5 bar 30 min) / IP69
Faixa de temperatura -40 °C - 100 °C
Nível de perigo EN gem. 45545 R22=HL3 / R23=HL3 / R24=HL3
Material Pressa Cabo de Aço inoxidável A2 (1.4305), Inserção de fixação Poliamida UL94-V0, Cones de aterramento: Latão cromado, Vedação de EPDM

Type	WISKA-No.						TL (mm)	
ESSKV 12 EMV-Z RW	10105857	M 12x1,5	5	3 - 7	5	17	23 - 30	10
ESSKV 16 EMV-Z RW	10105858	M 16x1,5	5	4,5 - 10	7,5	22	26 - 34	10
ESSKV 20 EMV-Z RW	10105859	M 20x1,5	6	6 - 13	9,5	24	29 - 37	10
ESSKV 25 EMV-Z RW	10105860	M 25x1,5	7	9 - 17	16	30	33 - 42	10
ESSKV 32 EMV-Z RW	10105861	M 32x1,5	8	13 - 21	20	36	36 - 44	5
ESSKV 40 EMV-Z RW	10105862	M 40x1,5	8	16 - 28	26	46	44 - 55	5
ESSKV 50 EMV-Z RW	10105863	M 50x1,5	9	21 - 35	33	55	51 - 62	2
ESSKV 63 EMV-Z RW	10105864	M 63x1,5	10	34 - 48	45	68	56 - 67	1

Accessórios Recomendados



Pressa Cabo Ferroviário - Railway SPRINT® EMC Baixa Temperatura cone de aterramento DIN 89345, ESKV LT EMV-Z RW, aço inoxidável, métrico, EN 45545

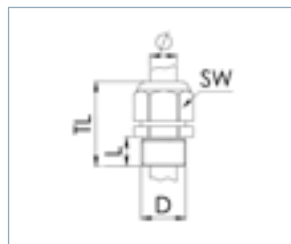

ESKLV LT EMV-Z RW



Classe de proteção IP68 (5 bar 30 min) / IP69
Faixa de temperatura -60 °C - 100 °C
Nível de perigo EN gem. 45545 R22=HL3 / R23=HL3 / R24=HL3
Material Pressa Cabo de Aço inoxidável A2 (1.4305), Inserção de fixação Poliamida UL94-V0, Cones de aterramento: Latão cromado, Vedação de Silicone

Type	WISKA-No.						TL (mm)	
ESKLV 12 LT EMV-Z RW	10105865	M 12x1,5	5	3 - 7	5	17	23 - 30	10
ESKLV 16 LT EMV-Z RW	10105866	M 16x1,5	5	4,5 - 10	7,5	22	26 - 34	10
ESKLV 20 LT EMV-Z RW	10105867	M 20x1,5	6	6 - 13	9,5	24	29 - 37	10
ESKLV 25 LT EMV-Z RW	10105868	M 25x1,5	7	9 - 17	16	30	33 - 42	10
ESKLV 32 LT EMV-Z RW	10105869	M 32x1,5	8	13 - 21	20	36	36 - 44	5
ESKLV 40 LT EMV-Z RW	10105870	M 40x1,5	8	16 - 28	26	46	44 - 55	5

Acessórios Recomendados



RDE LT

BS

ESMU

ORD-S

PLÁSTICO
 METAL
 MARÍTIMO
 EMC
 EX E/I
 EX D
 FERROVIÁRIO
 EQUALIZAÇÃO / VENTILAÇÃO
 PADRÃO BRITÂNICO
 VEDAÇÕES
 MEMBRANA
 CONMAXX
 CONMAXX GLAND
 BRACE FITTING PLÁSTICO
 BRACE CONDUIT PLÁSTICO
 BRACE FITTING METAL
 BRACE CONDUIT METAL

SPRINT® Vedações



MFD RW



RDE RW



Classe de proteção IP66 / IP68
Faixa de temperatura -40 °C - 100 °C

MFD RW , Elastômero termoplástico, branquinho

Type	WISKA-No.	 (mm)			
MFD 12/02/020 RW	10105927	1 - 2	2	SPRINT 12	25
MFD 12/04/020 RW	10105928	1,5 - 2	4	SPRINT 12	25
MFD 16/02/040 RW	10105929	2 - 4	2	SPRINT 16	25
MFD 16/03/021 RW	10105930	1 - 2,1	3	SPRINT 16	25
MFD 20/02/050 RW	10105931	4 - 5	2	SPRINT 20	25
MFD 20/03/040 RW	10105932	2,5 - 4	3	SPRINT 20	25
MFD 25/02/070 RW	10105549	5 - 7	2	SPRINT 25	25
MFD 25/02/070-01/040 RW	10105550	3 - 7	3	SPRINT 25	25
MFD 25/02/080 RW	10105548	6 - 8	2	SPRINT 25	25
MFD 32/01/115-01/050 RW	10105553	4 - 11,5	2	SPRINT 32	25
MFD 32/03/080 RW	10105552	6 - 8	3	SPRINT 32	25
MFD 32/04/080 RW	10105547	6 - 8	4	SPRINT 32	25
MFD 40/02/120-01/070 RW	10105546	7 - 12	3	SPRINT 40	25
MFD 40/04/100 RW	10105933	8 - 10	4	SPRINT 40	25
MFD 40/07/070 RW	10105934	5 - 7	7	SPRINT 40	25
MFD 50/09/080 RW	10105935	6 - 8	9	SPRINT 50	25
MFD 50/25/050 RW	10105936	4 - 5	25	SPRINT 50	25
MFD 63/03/065 RW	10105937	5 - 6,5	3	SPRINT 63	25
MFD 75/03/220 RW	10105588	20 - 22	3	SPRINT 75	25

RDE RW, EPDM, negro

Type	WISKA-No.	 (mm)		
RDE 12 RW	10105370	1 - 3	SPRINT 12	50
RDE 16 RW	10105371	2 - 6	SPRINT 16	50
RDE 20 RW	10105372	4 - 8	SPRINT 20	50
RDE 25 RW	10105373	7 - 12	SPRINT 25	25
RDE 32 RW	10105374	9 - 14	SPRINT 32	25
RDE 40 RW	10105375	12 - 20	SPRINT 40	10
RDE 50 RW	10105376	16 - 25	SPRINT 50	10
RDE 63 RW	10105377	28 - 38	SPRINT 63	10



Equalização de pressão com ventilação

Reduzir falhas de equipamentos técnicos devido a água condensada, oferece aos nossos produtos ventilação e uma ótima compensação de pressão. Prensa cabos e elementos de compensação de pressão se faz por sua membrana permeável ao ar e garante uma equalização de pressão entre o ambiente interior e exterior e é resistente à radiação UV, óleos, Gorduras e água salgada.

Prensa Cabo VentGLAND® SPRINT®, ESVG, poliamida, métrica, EN 62444

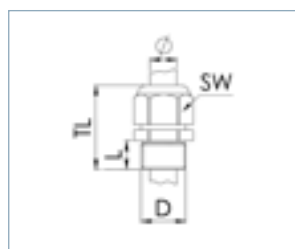

ESVG



Classe de proteção IP68 / IP69
Teste de fio incandescente 750 °C
Faixa de temperatura -40 °C - 100 °C
Material Prensa Cabo de Poliamida, Vedação de EPDM, Membrana ePTFE

Type	WISKA-No. RAL 7035	WISKA-No. RAL 9005	D (mm)	L (mm)	A (mm)	SW (mm)	TL (mm)	U/h	
ESVG 16	10104412	10104413	M 16x1,5	9	4,5 · 10	20	37 · 43	52	1
ESVG 20	10060974	10060802	M 20x1,5	10	6 · 13	24	41 · 50	42	1
ESVG 25	10100666	10100667	M 25x1,5	10	9 · 17	29	45 · 54	65	1
ESVG 32	10100801	10100802	M 32x1,5	12	13 · 21	36	49 · 58	115	1
ESVG 40	10102471	10102472	M 40x1,5	12	16 · 28	46	52 · 65	150	1

Accessórios Recomendados



EMUG

RDE

BS

MFD

Prensa Cabo VentGLAND® SPRINT®, EMSVG, latão níquelado, métrico, EN 62444



EMSVG

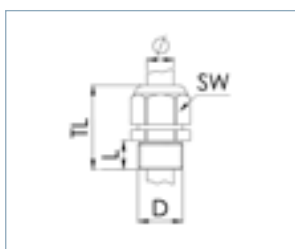

Classe de proteção
Faixa de temperatura
Material

IP68 / IP69
-40 °C - 100 °C
Prensa Cabo de Latão níquelado, Vedação de EPDM, Inserção de fixação Poliamida, Membrana ePTFE

Type	WISKA-No.	D (mm)	L (mm)	Ø (mm)	SW (mm)	TL (mm)	U/h	
EMSVG 16	10065899	M 16x1,5	6	4,5 - 10	20	34 - 42	52	1
EMSVG 20	10065900	M 20x1,5	6	6 - 13	24	41 - 50	55	1
EMSVG 25	10065901	M 25x1,5	7	9 - 17	29	43 - 52	90	1
EMSVG 32	10065902	M 32x1,5	8	13 - 21	36	47 - 56	115	1
EMSVG 40	10065903	M 40x1,5	8	16 - 28	46	57 - 70	150	1
EMSVG 50	10065904	M 50x1,5	9	21 - 35	55	64 - 77	225	1
EMSVG 63	10065905	M 63x1,5	10	34 - 48	68	69 - 83	285	1

Acessórios Recomendados

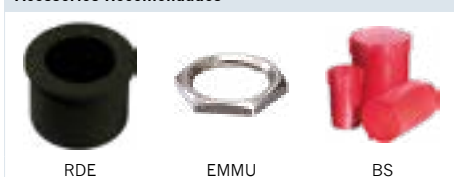

RDE

EMMU

BS

PLÁSTICO
METAL
MARÍTIMO
EMC
EX E/I
EX D
FERROVIÁRIO
EQUILIBRAÇÃO / VENTILAÇÃO
PADRÃO BRITÂNICO
VEDAÇÕES
MEMBRANA
CONMAXX
CONMAXX GLAND
BRACE FITTING PLÁSTICO
BRACE CONDUIT PLÁSTICO
BRACE FITTING METAL
BRACE CONDUIT METAL

Pressa Cabo de VentGLAND® SPRINT®, ESSVG, aço inoxidável, métrico, EN 62444



ESSVG



ESSVG-4

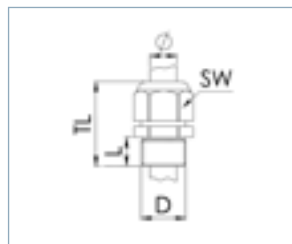

Classe de proteção
Faixa de temperatura
Material

IP68 / IP69
-40 °C - 100 °C
Pressa Cabo de Aço inoxidável A2 (1.4305), Vedação de EPDM, Inserção de fixação Poliamida, Membrana ePTFE

ESSVG, aço inoxidável 1.4305

Type	WISKA-No.					TL (mm)	U/h	
ESSVG 16	10104410	M 16x1,5	6	4,5 - 10	20	34 - 42	52	1
ESSVG 20	10069400	M 20x1,5	6	6 - 13	24	41 - 50	55	1
ESSVG 25	10069401	M 25x1,5	7	9 - 17	30	43 - 52	90	1
ESSVG 32	10069402	M 32x1,5	8	13 - 21	36	47 - 56	115	1
ESSVG 40	10069403	M 40x1,5	8	16 - 28	46	57 - 70	150	1
ESSVG 50	10069404	M 50x1,5	9	21 - 35	55	64 - 77	225	1
ESSVG 63	10069405	M 63x1,5	10	34 - 48	68	69 - 83	285	1

ESSVG-4, aço inoxidável 1.4404

Type	WISKA-No.					TL (mm)	U/h	
ESSVG-4 16	10104411	M 16x1,5	6	4,5 - 10	20	34 - 42	52	1
ESSVG-4 20	10069500	M 20x1,5	6	6 - 13	24	41 - 50	55	1
ESSVG-4 25	10069501	M 25x1,5	7	9 - 17	30	43 - 52	90	1
ESSVG-4 32	10069502	M 32x1,5	8	13 - 21	36	47 - 56	115	1
ESSVG-4 40	10069503	M 40x1,5	8	16 - 28	46	57 - 70	150	1
ESSVG-4 50	10069504	M 50x1,5	9	21 - 35	55	64 - 77	225	1
ESSVG-4 63	10069505	M 63x1,5	10	34 - 48	68	69 - 83	285	1

Accessórios Recomendados



Prensa Cabo EMC VentGLAND® SPRINT® com inserto de mola de contato, EMSVG EMV-S, latão niquelado, métrico, EN 62444



EMSVG EMV-S

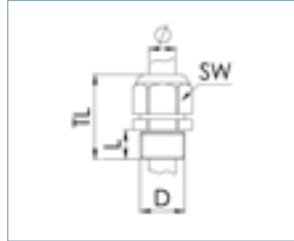

Classe de proteção
Faixa de temperatura
Material

IP68 / IP69
-40 °C - 100 °C
Prensa Cabo de Latão niquelado, Inserção de fixação Poliamida, Vedação de EPDM, Membrana ePTFE, Cones de aterramento: Aço inoxidável 1.4310

Type	WISKA-No.					l/h	TL (mm)	
EMSVG 20 EMV-S	10102715	M 20x1,5	6	6 · 13	24	55	41 · 50	1
EMSVG 25 EMV-S	10102716	M 25x1,5	7	9 · 17	29	90	43 · 52	1
EMSVG 32 EMV-S	10102717	M 32x1,5	8	13 · 21	36	115	47 · 56	1
EMSVG 40 EMV-S	10102718	M 40x1,5	8	16 · 28	46	150	57 · 70	1
EMSVG 50 EMV-S	10102719	M 50x1,5	9	21 · 35	55	225	64 · 77	1
EMSVG 63 EMV-S	10102720	M 63x1,5	10	34 · 48	68	285	69 · 83	1

Accessórios Recomendados



RDE

EMMU-EMV

BS

PLÁSTICO
METAL
MARÍTIMO
EMC
EX E/I
EX D
FERROVIÁRIO
EQUILIBRAÇÃO / VENTILAÇÃO
PADRÃO BRITÂNICO
VEDAÇÕES
MEMBRANA
CONMAXX
CONMAXX GLAND
BRACE FITTING PLÁSTICO
BRACE CONDUIT PLÁSTICO
BRACE FITTING METAL
BRACE CONDUIT METAL

Unidade de compensação de pressão de VentPLUG, EVPS, poliamida, métrica



EVPS 12



EVPS 12 HF

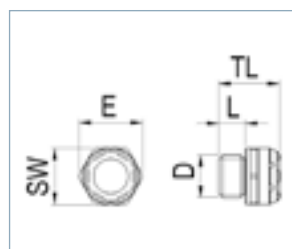

Classe de proteção
Faixa de temperatura
Material

IP68 / IP69
-40 °C - 100 °C
Poliamida, Vedação de TPE, Membrana ePTFE

EVPS

Type	WISKA-No. RAL 7035	WISKA-No. RAL 9005			E (mm)		l/h	TL (mm)	
EVPS 12	10102369	10102370	M 12x1,5	8	18	16	22	17,4	10
EVPS 20	10106591	10106595	M 20x1,5	9	27	24	110	15,4	10
EVPS 40	10106593	10106597	M 40x1,5	9	51	46	660	15,4	10

EVPS HF, alto fluxo de ar

Type	WISKA-No. RAL 7035	WISKA-No. RAL 9005			E (mm)		l/h	TL (mm)	
EVPS 12 HF	10103263	10103264	M 12x1,5	8	18	16	34	17,4	10
EVPS 20 HF	10106615	10106619	M 20x1,5	9	27	24	280	15,4	10
EVPS 40 HF	10106617	10106621	M 40x1,5	9	51	46	1650	15,4	10

EVPS-L, longo

Type	WISKA-No. RAL 7035	WISKA-No. RAL 9005			E (mm)		l/h	TL (mm)	
EVPS-L 20	10106592	10106596	M 20x1,5	15	27	24	110	21,4	10
EVPS-L 40	10106594	10106598	M 40x1,5	18	51	46	660	24,4	10

EVPS-L HF, Fluxo de Ar Alto, longo

Type	WISKA-No. RAL 7035	WISKA-No. RAL 9005			E (mm)		l/h	TL (mm)	
EVPS-L 20 HF	10106616	10106620	M 20x1,5	15	27	24	280	21,4	10
EVPS-L 40 HF	10106618	10106622	M 40x1,5	18	51	46	1650	24,4	10

Accesórios Re- comendados



Unidade de compensação de pressão de VentPLUG, EMVPS, latão niquelado, métrico



EMVPS



EMVPS HF

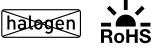
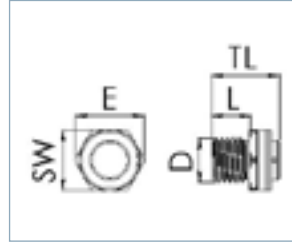

Classe de proteção
Faixa de temperatura
Material

IP68 / IP69
-40 °C - 100 °C
Latão niquelado, Vedação de EPDM, Membrana ePTFE

EMVPS

Type	WISKA-No. Niquelado	D (mm)	L (mm)	E (mm)	SW (mm)	l/h	TL (mm)	
EMVPS 12	10103265	M 12x1,5	10	18	16	22	17,5	10

EMVPS HF, alto fluxo de ar

Type	WISKA-No. Niquelado	D (mm)	L (mm)	E (mm)	SW (mm)	l/h	TL (mm)	
EMVPS 12 HF	10103266	M 12x1,5	10	18	16	34	17,5	10

Acessórios Recomendados

EMMU

- PLÁSTICO
- METAL
- MARÍTIMO
- EMC
- EX E/I
- EX D
- FERROVIÁRIO
- EQUALIZAÇÃO / VENTILAÇÃO
- PADRÃO BRITÂNICO
- VEDAÇÕES
- MEMBRANA
- CONMAXX
- CONMAXX GLAND
- BRACE FITTING PLÁSTICO
- BRACE CONDUIT PLÁSTICO
- BRACE FITTING METAL
- BRACE CONDUIT METAL

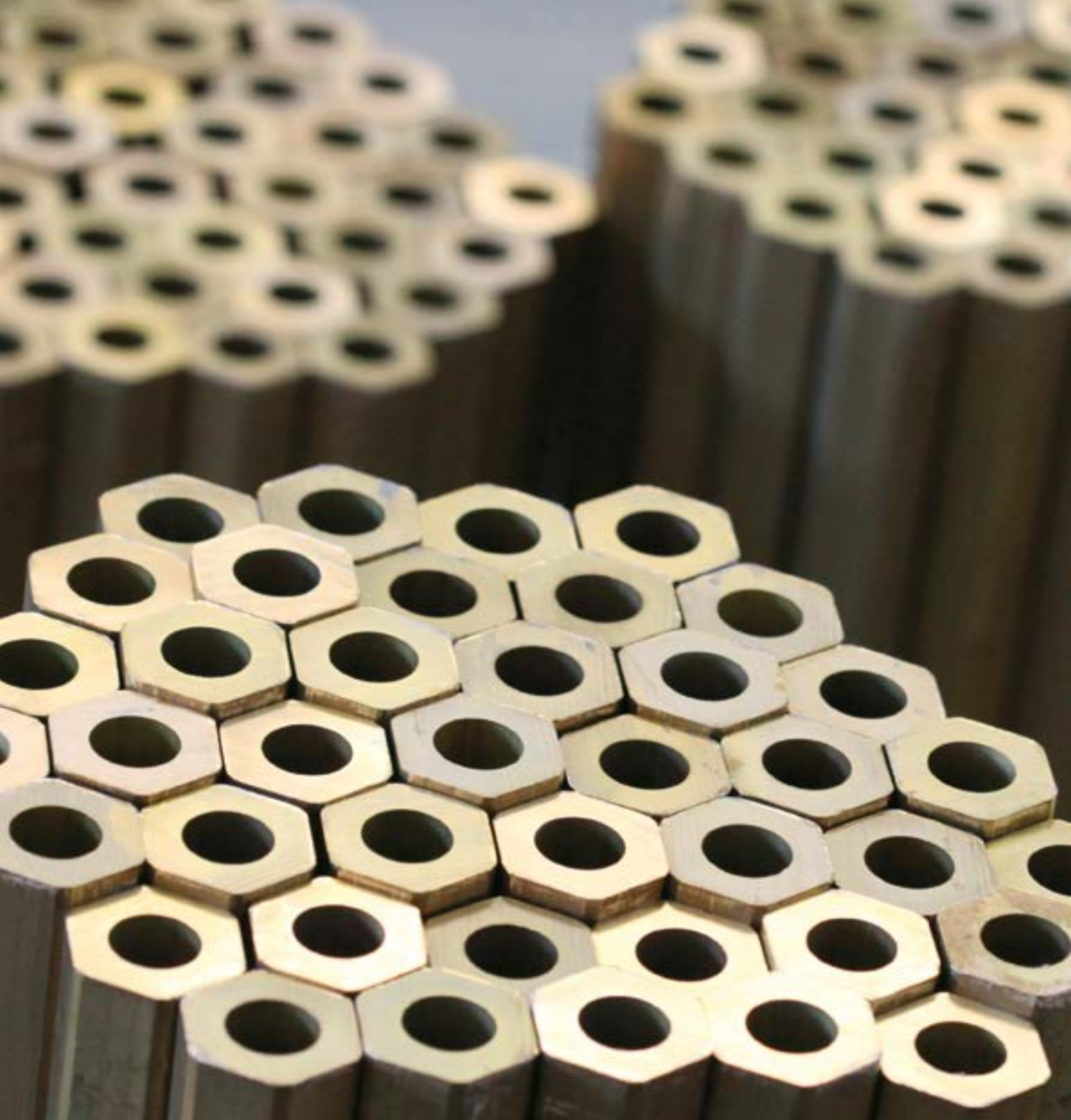

Prensa Cabo padrão britânico

Com os nossos prensa cabos em conformidade com o Padrão Britânico (BS) 6121, oferecemos produtos para instalações realizadas na Grã-Bretanha e outros países da Comunidade Britânica de Nações. Devido ao uso de cabos blindados de fio de aço, estes locais exigem o uso de versões especiais de prensa-cabos.

Packs de prensa cabo , BW Pack, latão, BS 6121

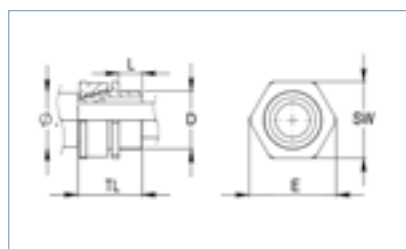

BWP Pack

Classe de proteção IP20
Faixa de temperatura -80 °C - 300 °C
Material Latão

Pacote BWP Premium

Type	WISKA-No. Branco	D (mm)	L (mm)	(mm)	(mm)	SW (mm)	TL (mm)	
BWP 20S Pack	50101701	M 20x1,5	10	- 15,8	-11,8	22	26	2
BWP 20 Pack	50101702	M 20x1,5	10	- 20,8	-13,8	27	28	2
BWP 25 Pack	50101703	M 25x1,5	10	- 27,5	-19,8	34	30	2
BWP 32 Pack	50101704	M 32x1,5	10	- 33,5	-26,4	41	31	2
BWP 40 Pack	50101705	M 40x1,5	15	- 40,9	-32,4	50	38	1
BWP 50S Pack	50101706	M 50x1,5	15	- 46,3	-38	59	39,5	1
BWP 50 Pack	50101707	M 50x1,5	15	- 52,6	-44	65	39,5	1
BWP 63S Pack	50101708	M 63x1,5	15	- 61,5	-49	75	44	1
BWP 63 Pack	50101709	M 63x1,5	15	- 65,3	-55,5	80	44	1
BWP 75S Pack	50101710	M 75x1,5	20	- 73	-62	90	53	1
BWP 75 Pack	50101711	M 75x1,5	20	- 78	-67	95	53	1
BWP 90 Pack	50101712	M 90x1,5	20	- 90	-79	106	57	1

Pacote BW, Economico

Type	WISKA-No. Branco	D (mm)	L (mm)	(mm)	SW (mm)	TL (mm)	
BW 20S Pack	50101693	M 20x1,5	10	- 15,5	21	29	2
BW 20L Pack	50101694	M 20x1,5	10	- 18,3	24	29	2
BW 25 Pack	50101695	M 25x1,5	10	- 25,4	32	34	2
BW 32 Pack	50101696	M 32x1,5	10	- 32,2	38	34	2
BW 40 Pack	50101697	M 40x1,5	15	- 38,5	46	43	1
BW 50 Pack	50101698	M 50x1,5	15	- 52	60	45	1
BW 63 Pack	50101699	M 63x1,5	15	- 64,7	74	50	1
BW 75 Pack	50101700	M 75x1,5	20	- 78	92	62	1

Packs de prensa cabo , CW Pack, latão, BS 6122



CWP Pack

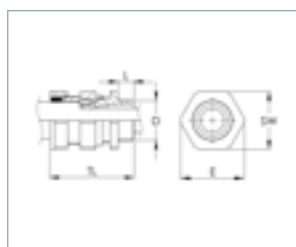

Classe de proteção IP66
Faixa de temperatura -20 °C - 80 °C
Material Latão

CWP Pack, Premium, para cabo blindado

Type	WISKA-No. Branco						TL (mm)	
CWP 20SS Pack	50101680	M 20x1,5	10	8,4 · 13,8	-9	22	48	2
CWP 20S Pack	50101681	M 20x1,5	10	12,9 · 15,8	-11,8	24	50	2
CWP 20 Pack	50101682	M 20x1,5	10	15,5 · 20,8	-13,8	30	51	2
CWP 25 Pack	50101683	M 25x1,5	10	20,3 · 27,5	-19,8	38	54	2
CWP 32 Pack	50101684	M 32x1,5	10	26,7 · 33,5	-26,4	46	58	2
CWP 40 Pack	50101685	M 40x1,5	15	33 · 40,9	-32,4	55	67	1
CWP 50S Pack	50101686	M 50x1,5	15	39,4 · 46,3	-38	60	70	1
CWP 50 Pack	50101687	M 50x1,5	15	45,7 · 52,6	-44	65	70	1
CWP 63S Pack	50101688	M 63x1,5	15	52,1 · 61,5	-44	75	75	1
CWP 63 Pack	50101689	M 63x1,5	15	58,4 · 65,3	-55,5	80	75	1
CWP 75S Pack	50101690	M 75x1,5	20	64,8 · 73	-62	90	85	1
CWP 75 Pack	50101691	M 75x1,5	20	71 · 78	-67	95	85	1
CWP 90 Pack	50101692	M 90x1,5	20	81 · 90	-79	110	90	1

Pacote CW, Economia





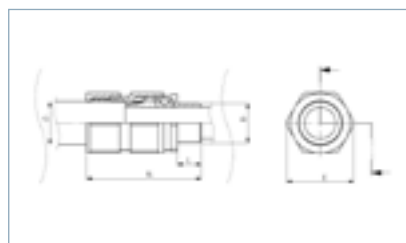

Type	WISKA-No. Branco						TL (mm)	
CW 20S Pack	50101673	M 20x1,5	10	12,8 · 15,5	-11,8	24	48	2
CW 20L Pack	50101674	M 20x1,5	10	15,5 · 19,5	-13,6	27	49	2
CW 25 Pack	50101675	M 25x1,5	10	22 · 26,5	-20	35	54	2
CW 32 Pack	50101676	M 32x1,5	10	26 · 33,5	-26,5	43	58	2
CW 40 Pack	50101677	M 40x1,5	15	33 · 39,5	-32,1	51	67	1
CW 50 Pack	50101678	M 50x1,5	15	45 · 52	-42,2	63	70	1
CW 63 Pack	50101679	M 63x1,5	15	59 · 66	-55,2	79	75	1

Packs de prensa cabo para cabos blindados de fio único, E1W Pack, premium, latão, BS 6121



E1W Pack

Classe de proteção IP66 / IP68
Faixa de temperatura -20 °C - 80 °C
Material Latão





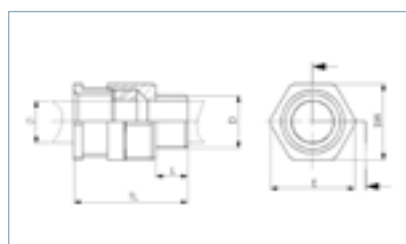

Type	WISKA-No. Branco	 D (mm)	 L (mm)	 (mm)	 (mm)	 SW (mm)	TL (mm)	
E1W 20S Pack	50101655	M 20x1,5	15	12,9 - 15,8	8 - 11,8	24	57	2
E1W 20 Pack	50101656	M 20x1,5	15	15,5 - 20,8	11 - 13,8	30	58	2
E1W 25 Pack	50101657	M 25x1,5	15	20,3 - 27,5	13 - 19,8	38	61	2
E1W 32 Pack	50101658	M 32x1,5	15	26,7 - 33,5	19 - 26,4	46	65	2
E1W 40 Pack	50101659	M 40x1,5	20	33 - 40,9	25 - 32,4	55	74,5	1
E1W 50 Pack	50101660	M 50x1,5	20	39,4 - 46,3	31,5 - 38	60	77,5	1
E1W 50L Pack	50101661	M 50x1,5	20	45,7 - 52,6	36,5 - 44	65	77,5	1
E1W 63S Pack	50101662	M 63x1,5	20	52,1 - 61,5	42,5 - 49	75	83	1
E1W 63L Pack	50101663	M 63x1,5	20	58,4 - 65,3	48,5 - 55,5	80	83	1
E1W 75S Pack	50101664	M 75x1,5	20	64,8 - 73	54,5 - 62	90	88	1
E1W 75 Pack	50101665	M 75x1,5	20	71 - 78	60,5 - 67	95	88	1

Packs de prensa cabo para cabos trançados, CXTP Pack, premium, latão, BS 6121



CXTP Pack

Classe de proteção IP66
Faixa de temperatura -20 °C - 80 °C
Material Latão

Type	WISKA-No. Branco	 D (mm)	 L (mm)	 (mm)	 (mm)	 SW (mm)	TL (mm)	
CXTP 20S Pack	50101666	M 20x1,5	15	7 - 11,6		24	33	2
CXTP 20L Pack	50101667	M 20x1,5	15	10,5 - 13,6		27	35	2
CXTP 25 Pack	50101668	M 25x1,5	15	12,5 - 19,8		36	41	2
CXTP 32 Pack	50101669	M 32x1,5	15	18,5 - 26,3		41	41	2
CXTP 40 Pack	50101670	M 40x1,5	20	25 - 32,1		50	47	1
CXTP 50 Pack	50101671	M 50x1,5	20	36,5 - 44		60	47	1
CXTP 63 Pack	50101672	M 63x1,5	20	48,5 - 55		75	69	1



Vedações

Nossa ampla gama de insertos de redução, múltiplos e especiais pode ser combinada com todos os prensa cabos e materiais do sistema de prensa cabos SPRINT, atendendo pelo menos o padrão IP66. Além das versões individuais, a WISKA também oferece vários materiais para usos especiais, ou seja, baixas temperaturas.

Insertos de vedação de redução SPRINT®, RDE





RDE



Classe de proteção
Faixa de temperatura
Material

IP68
-40 °C - 100 °C
EPDM

Type	WISKA-No. RAL 9005	 (mm)		
RDE 12	10062183	1 · 3	SPRINT 12	50
RDE 16	10062184	2 · 6	SPRINT 16	50
RDE 20	10062185	4 · 8	SPRINT 20	50
RDE 25	10060768	7 · 12	SPRINT 25	25
RDE 32	10062186	9 · 14	SPRINT 32	25
RDE 40	10062187	12 · 20	SPRINT 40	10
RDE 50	10062188	16 · 25	SPRINT 50	10
RDE 63	10062189	28 · 38	SPRINT 63	10

Insertos de vedação de redução SPRINT® Baixa Temperatura LowTemp, RDE LT





RDE LT



Classe de proteção
Faixa de temperatura
 Cor
Material

IP68
 -60 °C - 100 °C
 Vermelho
 Silicone

Type	WISKA-No.	 (mm)		
RDE 12 LT	10063981	1 - 3	SPRINT 12	50
RDE 16 LT	10063908	2 - 6	SPRINT 16	50
RDE 20 LT	10063909	4 - 8	SPRINT 20	50
RDE 25 LT	10063910	7 - 12	SPRINT 25	25
RDE 32 LT	10063934	9 - 14	SPRINT 32	25
RDE 40 LT	10063960	12 - 20	SPRINT 40	10
RDE 50 LT	10063966	16 - 25	SPRINT 50	10
RDE 63 LT	10063967	28 - 38	SPRINT 63	10

PLÁSTICO

METAL

MARÍTIMO

EMC

EX E/I

EX D

FERROVIÁRIO

EQUILIBRAÇÃO /
VENTILAÇÃOPADRÃO
BRITÂNICO

VEDAÇÕES

MEMBRANA

CONMAXX

CONMAXX
GLANDBRACE
FITTING
PLÁSTICOBRACE
CONDUIT
PLÁSTICOBRACE
FITTING
METALBRACE
CONDUIT
METAL





Insertos de vedação múltipla SPRINT®, MFD







MFD



Classe de proteção IP66 / IP68
Faixa de temperatura -40 °C - 100 °C
Cor Preto
Material Elastômero termoplástico

Type	WISKA-No. RAL 9005	 (mm)	 n		
MFD 12/01/015	10102489	1 · 1,5	1	SPRINT 12	25
MFD 12/02/020	10100525	1 · 2	2	SPRINT 12	25
MFD 12/04/020	10064392	1,5 · 2	4	SPRINT 12	25
MFD 16/02/040	10064393	2 · 4	2	SPRINT 16	25
MFD 16/03/021	10101014	1 · 2,1	3	SPRINT 16	25
MFD 20/01/090	10102841	7 · 9	1	SPRINT 20	25
MFD 20/02/050	10101015	4 · 5	2	SPRINT 20	25
MFD 20/02/060	10064395	4 · 6	2	SPRINT 20	25
MFD 20/02/065	10060953	5 · 6,5	2	SPRINT 20	25
MFD 20/03/040	10064341	2,5 · 4	3	SPRINT 20	25
MFD 20/03/045	10102306	2,5 · 4,5	3	SPRINT 20	25
MFD 20/04/030	10102722	2 · 3	4	SPRINT 20	25
MFD 20/05/030	10102853	2 · 3	5	SPRINT 20	25
MFD 25/01/065	10060954	4 · 6,5	1	SPRINT 25	25
MFD 25/01/090	10101016	7 · 9	1	SPRINT 25	25
MFD 25/01/105-01/055	10101255	4,5 · 10,5	2	SPRINT 25	25
MFD 25/02/030	10102655	2 · 3	2	SPRINT 25	25
MFD 25/02/060	10060452	4 · 6	2	SPRINT 25	25
MFD 25/02/070	10063995	5 · 7	2	SPRINT 25	25
MFD 25/02/070-01/040	10102979	2 · 7	3	SPRINT 25	25
MFD 25/02/080	10060952	6 · 8	2	SPRINT 25	25
MFD 25/03/045	10103325	3,5 · 4,5	3	SPRINT 25	25
MFD 25/03/070	10064342	5 · 7	3	SPRINT 25	25
MFD 25/04/060	10064343	4 · 6	4	SPRINT 25	25
MFD 25/05/056	10102023	4,6 · 5,6	5	SPRINT 25	25
MFD 32/01/060-02/090	10103653	4 · 9	3	SPRINT 32	25
MFD 32/01/115-01/050	10102794	4 · 11,5	2	SPRINT 32	25
MFD 32/01/115-01/085	10101256	7,5 · 11,5	2	SPRINT 32	25
MFD 32/02/080	10102743	6 · 8	2	SPRINT 32	25
MFD 32/02/85	10102493	6,5 · 8,5	2	SPRINT 32	25
MFD 32/03/065	10102169	5 · 6,5	3	SPRINT 32	25
MFD 32/03/080	10101018	6 · 8	3	SPRINT 32	25
MFD 32/03/090	10102170	7 · 9	3	SPRINT 32	25
MFD 32/04/070	10064344	5 · 7	4	SPRINT 32	25
MFD 32/05/070	10101140	5 · 7	5	SPRINT 32	25
MFD 32/04/080	10064950	6 · 8	4	SPRINT 32	25
MFD 32/06/060	10064345	5 · 6	6	SPRINT 32	25
MFD 40/02/070-01/100-02/115	10102765	5 · 11,5	5	SPRINT 40	25
MFD 40/02/120-01/070	10102488	5 · 12	3	SPRINT 40	25
MFD 40/03/125	10102054	10,5 · 12,5	3	SPRINT 40	25
MFD 40/04/100	10101017	8 · 10	4	SPRINT 40	25
MFD 40/06/065	10102171	5 · 6,5	6	SPRINT 40	25
MFD 40/06/090	10102172	7 · 9	6	SPRINT 40	25
MFD 40/07/070	10064348	5 · 7	7	SPRINT 40	25

Type	WISKA-No. RAL 9005	 (mm)	 n		
MFD 40/07/080	10064347	6 - 8	7	SPRINT 40	25
MFD 40/08/060	10064346	5 - 6	8	SPRINT 40	25
MFD 40/08/070	10102744	5 - 7	8	SPRINT 40	25
MFD 40/09/069	10101427	5,5 - 6,9	9	SPRINT 40	25
MFD 50/09/080	10064394	6 - 8	9	SPRINT 50	25
MFD 50/15/050	10102745	4 - 5	15	SPRINT 50	25
MFD 50/16/060	10102746	4 - 6	16	SPRINT 50	25
MFD 50/25/050	10063102	4 - 5	25	SPRINT 50	25
MFD 63/01/131-01/118-03/084-02	10101114	5 - 13,1	7	SPRINT 63	25
MFD 63/02/065-01/090	10101223	5 - 9	3	SPRINT 63	25
MFD 63/03/065	10101201	5 - 6,5	3	SPRINT 63	25

Insertos especiais de vedação SPRINT®



GFD



FFD





SFD



Classe de proteção
Faixa de temperatura
Material

IP66
-40 °C - 100 °C
Elastômero termoplástico



FFD, para cabos planos

Type	WISKA-No. RAL 9005	 n		
FFD 20/01/056-102	10064322	1	SPRINT 20	25
FFD 20/01/070-130	10101192	1	SPRINT 20	25
FFD 25/01/077-159	10103326	1	SPRINT 25	25

SFD, para cabos ASi-Bus

Type	WISKA-No. RAL 9005	 n		
SFD 20/01/ASi	10064329	1	SPRINT 20	25

GFD, split, para cabos pré-fabricados

Type	WISKA-No. RAL 9005	 n		
GFD 20/01/015	10064328	1	SPRINT 20	25
GFD 20/01/060	10102297	1	SPRINT 20	25
GFD 25/01/050	10101019	1	SPRINT 25	25
GFD 25/01/060	10066632	1	SPRINT 25	25
GFD 32/01/045-01/085	10101145	2	SPRINT 32	25
GFD 32/01/073	10102359	1	SPRINT 32	25
GFD 50/01/080	10101020	1	SPRINT 50	25
GFD 63/01/090	10101536	1	SPRINT 63	25
GFD 63/02/065-01/090	10101224	3	SPRINT 63	25
GFD 63/03/065	10101200	3	SPRINT 63	25

Tampas cegas SPRINT®, BS



BS



SPRINT



Faixa de temperatura



-60 °C - 100 °C

Cor

Vermelho

Material

Poliamida

Type	WISKA-No.	 (mm)	TL (mm)	
BS 2	10064000	2	12	50
BS 3	10064001	3	12	50
BS 4	10064002	4	12	50
BS 5	10064003	5	12	50
BS 6	10064004	6	16	50
BS 7	10064005	7	16	50
BS 8	10064006	8	16	50
BS 9	10064007	9	16	50
BS 10	10064008	10	16	50
BS 12	10064009	12	22	50
BS 13	10064010	13	22	50
BS 14	10064011	14	22	50
BS 17	10064012	17	22	50
BS 20	10064013	20	22	25
BS 21	10064014	21	30	25
BS 25	10064015	25	30	25
BS 28	10064016	28	30	25
BS 35	10064017	35	35	10
BS 38	10064018	38	35	10
BS 48	10064019	48	35	10
BS 63	10064020	63	35	5

Juntas de rosca de conexão SPRINT®



EADR / ADR



EADR LT



Material

EPDM

EADR, SPRINT®, métrico, -40 °C · 140 °C

Type	WISKA-No. RAL 9005		TL (mm)	
EADR 12	10062801	M 12x1,5	2	100
EADR 16	10062802	M 16x1,5	2	100
EADR 20	10062803	M 20x1,5	2	100
EADR 25	10062804	M 25x1,5	2	100
EADR 32	10062805	M 32x1,5	2	100
EADR 40	10062806	M 40x1,5	2	100
EADR 50	10062807	M 50x1,5	2	100
EADR 63	10062808	M 63x1,5	2	100

EADR LT, SPRINT®, métrico, -60 °C · 140 °C

Type	WISKA-No. RAL 3000		TL (mm)	
EADR 12/90 LT	10105704	M 12x1,5	2	100
EADR 16/90 LT	10105705	M 16x1,5	2	100
EADR 20/90 LT	10105706	M 20x1,5	2	100
EADR 25/90 LT	10105707	M 25x1,5	2	100
EADR 32/90 LT	10105708	M 32x1,5	2	100
EADR 40/90 LT	10105709	M 40x1,5	2	100
EADR 50/90 LT	10105710	M 50x1,5	2	100
EADR 63/90 LT	10105711	M 63x1,5	2	100

ADR, PG, -40 °C · 140 °C

Type	WISKA-No. RAL 9005		TL (mm)	
ADR 7	10061419	PG 7	2	100
ADR 9	10061420	PG 9	2	100
ADR 11	10061421	PG 11	2	100
ADR 13,5	10061422	PG 13,5	2	100
ADR 16	10061423	PG 16	2	100
ADR 21	10061424	PG 21	3	100
ADR 29	10061425	PG 29	3	100
ADR 36	10061426	PG 36	3	100
ADR 42	10061427	PG 42	3	100
ADR 48	10061428	PG 48	3	100

O-ring SPRINT®, ORD



ORD-E



ORD-V

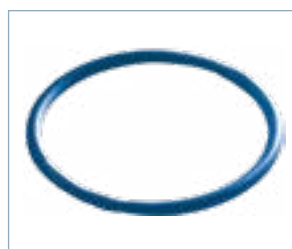

ORD_S



ORD-E, EPDM, -40 °C · 120 °C, preto

Type	WISKA-No.			
ORD-E 12	10064697	SPRINT 12	M 12x1,5	100
ORD-E 16	10064698	SPRINT 16	M 16x1,5	100
ORD-E 20	10064699	SPRINT 20	M 20x1,5	100
ORD-E 25	10064700	SPRINT 25	M 25x1,5	100
ORD-E 32	10064701	SPRINT 32	M 32x1,5	100
ORD-E 40	10064702	SPRINT 40	M 40x1,5	100
ORD-E 50	10064703	SPRINT 50	M 50x1,5	100
ORD-E 63	10064704	SPRINT 63	M 63x1,5	100
ORD-E 75	10101765	SPRINT 75	M 75x1,5	100

ORD-V, Viton, -15 °C · 200 °C, preto

Type	WISKA-No.			
ORD-V 12	10064705	SPRINT 12	M 12x1,5	100
ORD-V 16	10064706	SPRINT 16	M 16x1,5	100
ORD-V 20	10064707	SPRINT 20	M 20x1,5	100
ORD-V 25	10064708	SPRINT 25	M 25x1,5	100
ORD-V 32	10064709	SPRINT 32	M 32x1,5	100
ORD-V 40	10064710	SPRINT 40	M 40x1,5	100
ORD-V 50	10064711	SPRINT 50	M 50x1,5	100
ORD-V 63	10064712	SPRINT 63	M 63x1,5	100

ORD-S, Silikon, -60 °C · 180 °C, azul

Type	WISKA-No.			
ORD-S 12	10101757	SPRINT 12	M 12x1,5	100
ORD-S 16	10101758	SPRINT 16	M 16x1,5	100
ORD-S 20	10101759	SPRINT 20	M 20x1,5	100
ORD-S 25	10101760	SPRINT 25	M 25x1,5	100
ORD-S 32	10101761	SPRINT 32	M 32x1,5	100
ORD-S 40	10101762	SPRINT 40	M 40x1,5	100
ORD-S 50	10101763	SPRINT 50	M 50x1,5	100
ORD-S 63	10101764	SPRINT 63	M 63x1,5	100



As Entradas de Cabos Membranas

Quando os cabos precisam ser inseridos da maneira mais simples e rápida possível, as Membranas, (tipo passa-fio) entram em ação. Eles têm uma forma que economiza espaço e estão disponíveis em muitas versões diferentes para vários tipos de cabos. A WISKA produz as Membranas de Borracha com IP66 e IP67, são fabricadas em nossas instalações de injeção plástica por dupla injeção (twinshot) na cidade Kaltenkirchen na Alemanha.

Entradas de cabos de Membrana CLIXX® com alívio de tensão

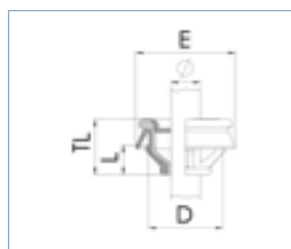

CLIXX



Classe de proteção IP66 / IP67
Faixa de temperatura -40 °C - 65 °C
Material Polipropileno, Membrana TPE

Type	WISKA-No. RAL 7035	WISKA-No. RAL 9001	WISKA-No. RAL 3000	WISKA-No. RAL 9005	D (mm)	(mm)	DD (mm)	S (mm)	TL (mm)	
CLIXX 16	10101861	10101932	10101931	10101930	16	4,5 - 10	16,7	0,8 - 3,5	15	50
CLIXX 20	10101359	10101935	10101934	10101933	20	6 - 13	20,7	0,8 - 3,5	15	50
CLIXX 25	10101862	10101938	10101937	10101936	25	9 - 17	25,7	0,8 - 3,5	15	50

Entrada de membrana múltipla MultiCLIXX® com tensão

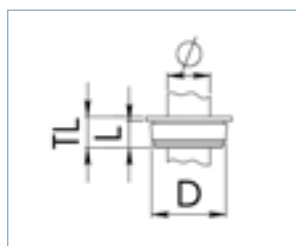

EMTZ



Classe de proteção IP66
Teste de fio incandescente 960 °C
Faixa de temperatura -30 °C - 80 °C
Material Polipropileno, Membrana TPE

Type	WISKA-No.	D (mm)	L (mm)	(mm)	ED (mm)	DD (mm)	TL (mm)	
EMTZ 32/02/120-02/080 V0	10108616	32	9,5	4 - 12	37	32	12	50

Entradas de cabo de Membrana QUIXX®, EMS, métrica



EMS



EMS

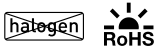
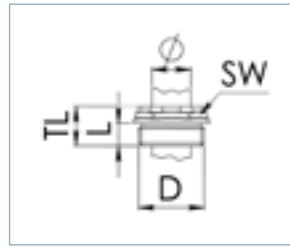

Classe de proteção
Faixa de temperatura
Material

IP66
-30 °C - 80 °C
Polipropileno, Membrana TPE

Type	WISKA-No. RAL 7035	D (mm)	L (mm)	Ø (mm)	SW (mm)	TL (mm)	
EMS 16	10062567	M 16x1,5	9	1 - 9	17	15	100
EMS 20	10062568	M 20x1,5	9	1 - 13	20	15	100
EMS 25	10062569	M 25x1,5	9	1 - 18	24	15	100
EMS 32	10062570	M 32x1,5	9	1 - 25	32	15	100

Acessórios Recomendados



EMUG

EADR

Entradas de cabo de Membrana QUIXX®, EMT



EMT



EMT

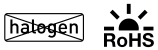
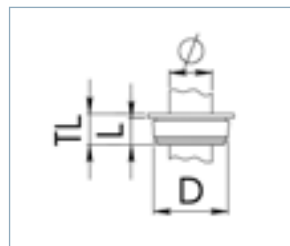

Classe de proteção
Faixa de temperatura
Material

IP66
-40 °C - 80 °C
Elastômero termoplástico

Type	WISKA-No. RAL 7035	D (mm)	L (mm)	Ø (mm)	TL (mm)	S (mm)	DD (mm)	
EMT 16	10062559	16	9,5	1 - 9	11	2	16,5	100
EMT 20	10062560	20	9,5	1 - 13	11	2	20,5	100
EMT 25	10062561	25	9,5	1 - 18	11	2	25,5	100
EMT 32	10062562	32	9,5	1 - 25	11	2	32	100

PLÁSTICO
METAL
MARÍTIMO
EMC
EX E/I
EX D
FERROVIÁRIO
EQUILIBRAÇÃO / VENTILAÇÃO
PADRÃO BRITÂNICO
VEDAÇÕES
MEMBRANA
CONMAXX
CONMAXX GLAND
BRACE FITTING PLÁSTICO
BRACE CONDUIT PLÁSTICO
BRACE FITTING METAL
BRACE CONDUIT METAL

Entradas de cabos de Membrana QUIXX® retardador de chama, EMT-F

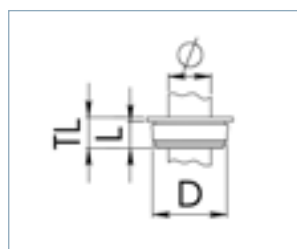

EMT-F



Classe de proteção IP66
Teste de fio incandescente 960 °C
Faixa de temperatura -40 °C - 80 °C
Material TPE, retardador de chama

Type	WISKA-No. branco				TL (mm)		DD (mm)	
EMT-F 16	10063008	16	9,5	1 - 9	11	2	16,5	100
EMT-F 20	10063009	20	9,5	1 - 13	11	2	20,5	100
EMT-F 25	10063010	25	9,5	1 - 18	11	2	25,5	100
EMT-F 32	10063011	32	9,5	1 - 25	11	2	32,5	100

Passa-fio FLIP, FD

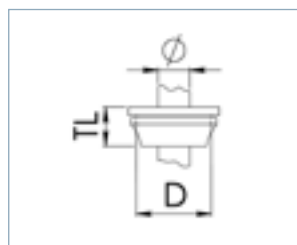

FD



Classe de proteção IP66 / IP67
Faixa de temperatura -40 °C - 110 °C
Material EPDM

Type	WISKA-No. RAL 9005	WISKA-No. RAL 7001			TL (mm)	DD (mm)		
FD 12	50062891	50062770	M 12	4 - 7	13	12 - 13	0,5 - 2	50
FD 16	50062892	50062771	M 16	5 - 9	18	15 - 17	1 - 4	50
FD 20	50062893	50062772	M 20	8 - 13	20	20 - 21	1 - 4	50
FD 25	50062894	50062773	M 25	11 - 17	21,5	25 - 26	1 - 4	50
FD 32	50062895	50062774	M 32	15 - 20	25	32 - 33	1 - 4	25
FD 40	50062896	50062775	M 40	19 - 28	30	40 - 41	1 - 4	25
FD 50	50062897	50062776	M 50	27 - 35	35	50 - 51	1 - 4	10



CONMAXX® – Blocos de Passagem Entrada de Cabos

Com a CONMAXX®, desenvolvemos um sistema de entrada de cabos especialmente projetado para instalações de painéis elétricos. O inovador sistema modular de 3 componentes que oferece uma nova dimensão de flexibilidade. Desta forma, você pode realizar até mesmo alterações subsequentes e individuais na fiação sem qualquer abertura e fechamento trabalhosos no seu quadro elétrico.



CONMAXX® - Um sistema de todas as possibilidades.

Com a CONMAXX®, temos um sistema de entrada de cabos especialmente para instalações de quadros elétricos e instalações com cabos pré-montados. O sistema consiste em um quadro fechado, inserções de grade variável e cônica e Elementos de vedação. É complementado pela vedação divisível do CONMAXX® Gland. Nossos Blocos de Passagem CONMAXX também é conhecido no mercado como "MCT".

É tão fácil instalar com o sistema CONMAXX®

Fora do painel:

- 1 Instalação do quadro de alojamento no painel do lado de fora

Dentro do painel/armário ou caixa de controle:

- 2 Insira os cabos nos elementos de vedação
- 3 Empurre a inserção na grade no painel
- 4 Pressione os elementos de vedação com os cabos na inserção da grade

Sistema CONMAXX®: Suas combinações possíveis com nosso sistema de Blocos de passagem tipo MCT par a Entrada de Cabos

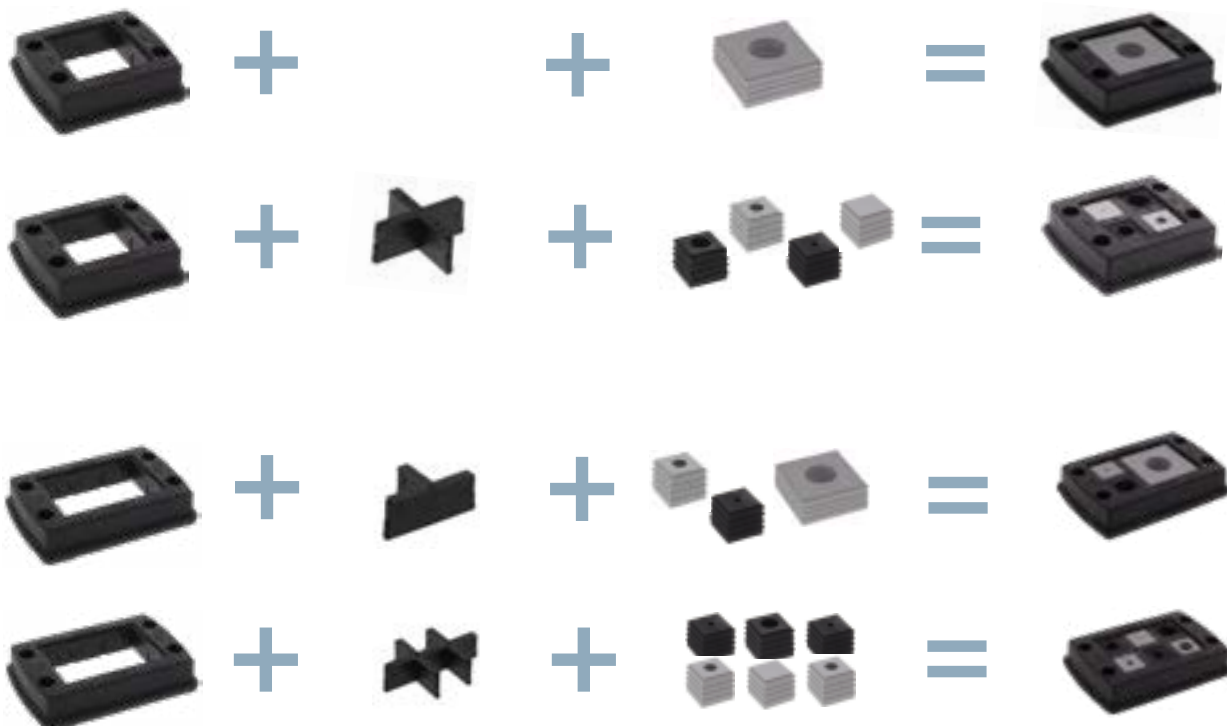

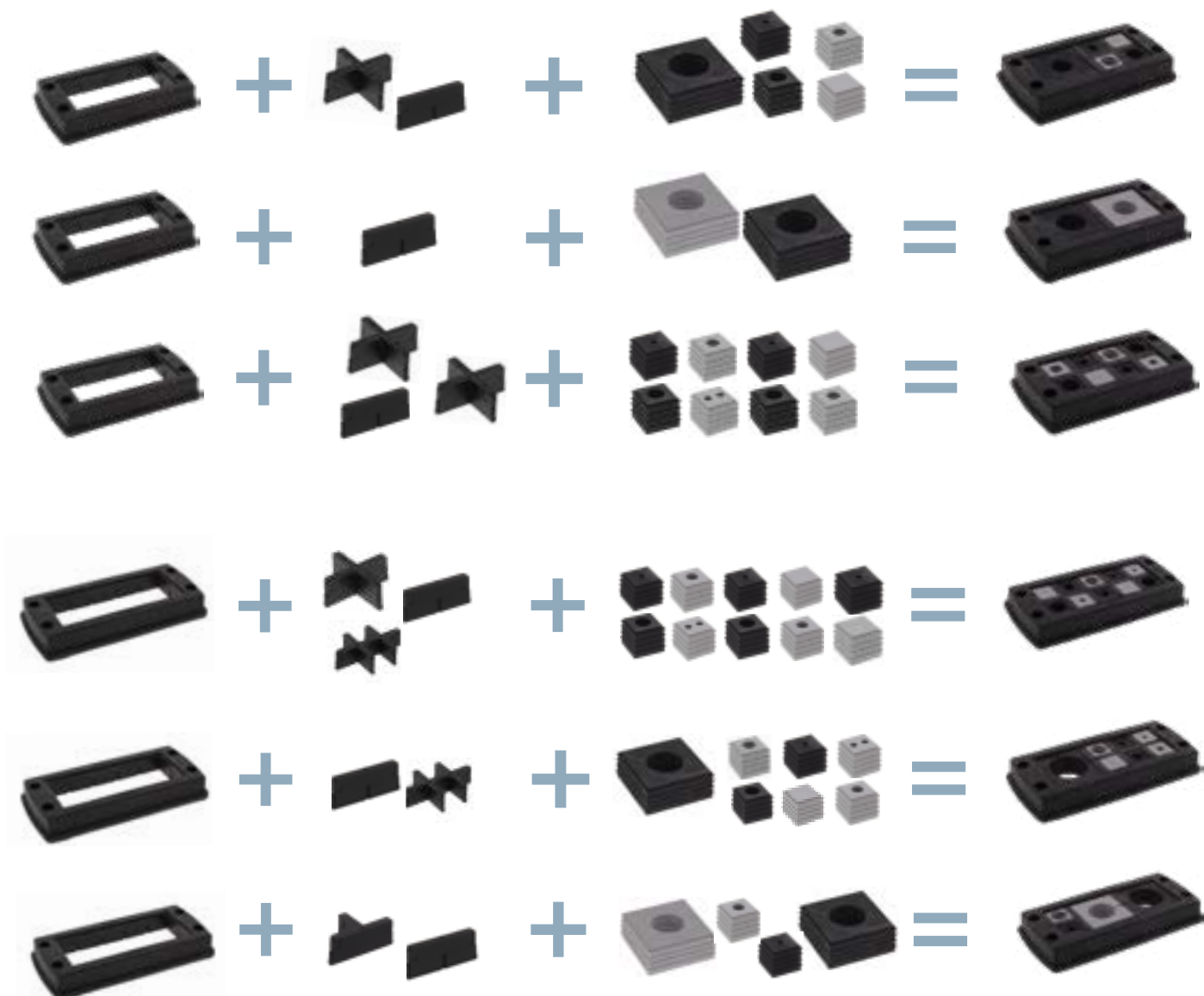

CONMAXX® Gland: As suas possibilidades de combinação com a nossa união roscada divisível

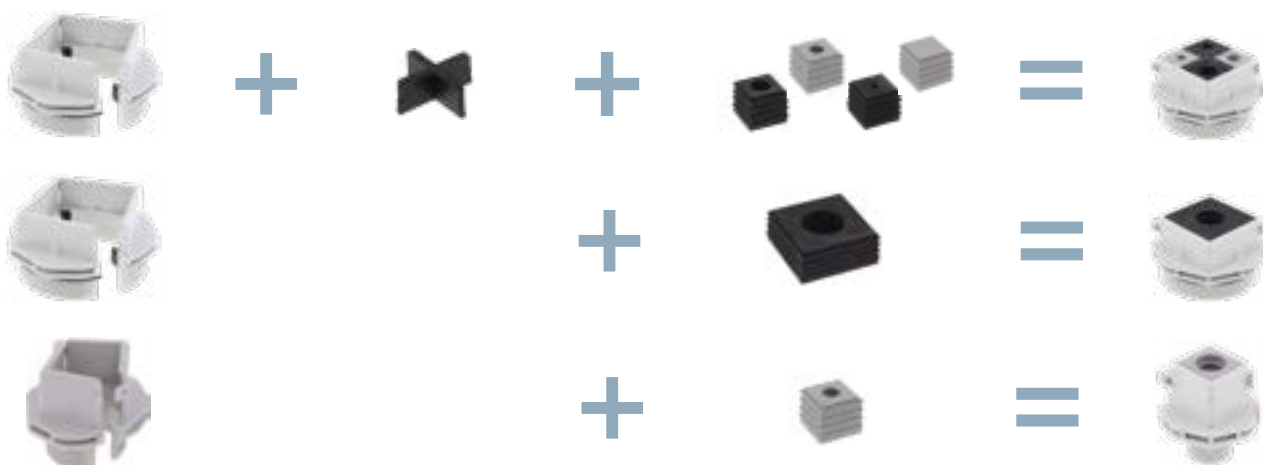

CONMAXX® Quadros e trava de quadros, CF e CV, em plástico



CF



CV



Classe de proteção IP66
Faixa de temperatura -40° C - 120 °C
Material Poliamida UL94-V0

CF, quadros, preto

Type	WISKA-No.	BxL (mm)	
CF 4-B1 V0 BK	10108180	70x81mm	1
CF 6-10 V0 BK	10108181	70x106mm	1
CF 8-16 V0 BK	10108182	70x126mm	1
CF 10-24 V0 BK	10108183	70x153mm	1

CV, quadros de bloqueio, preto

Type	WISKA-No.	BxL (mm)	
CV 4 V0 BK	10108184	69x80mm	1
CV 6 V0 BK	10108185	69x105mm	1
CV 8 V0 BK	10108186	69x125mm	1
CV 10 V0 BK	10108187	69x152mm	1

Acessórios Recomendados



CGX

CONMAXX® CGV de barra simples e grade T CGT, plástico

CGV



CGT

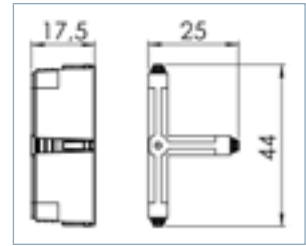
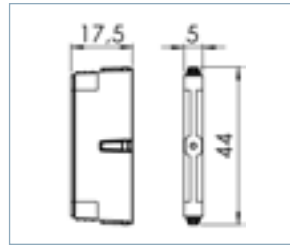

Classe de proteção
Faixa de temperatura
Cor
Material
CGV

IP66
-40° C - 120 °C
RAL 9005
Poliamida UL94-V0, Vedação de TPE

Type	WISKA-No.	
CGV V0 BK	10108188	1

CGT

Type	WISKA-No.	
CGT V0 BK	10108189	1

CONMAXX® grade cruzada CGX e dupla grade cruzada "Cross grid CGX and Double cross grid" CGH, plástico

CGX



CGH

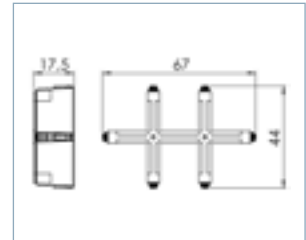
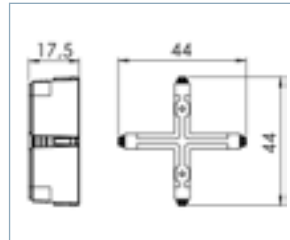

Classe de proteção
Faixa de temperatura
Cor
Material
CGX

IP66
-40° C - 120 °C
RAL 9005
Poliamida UL94-V0, Vedação de TPE

Type	WISKA-No.	
CGX V0 BK	10108190	1

CGH

Type	WISKA-No.	
CGH V0 BK	10108191	1

Vedações CONMAXX®







CONMAXX Seals



Classe de proteção
Faixa de temperatura
Material

IP66
-40° C - 120 °C
Elastômero termoplástico

Type	WISKA-No.	RAL-No.	 (mm)	BxL (mm)	
CDK 0 HB	10108192	RAL 9005	-	20,7 x 20,7 mm	10
CDKG 2 HB	10108193	RAL 9005	1,5 - 2	20,7 x 20,7 mm	10
CDKG 3 HB	10108194	RAL 9005	2 - 3	20,7 x 20,7 mm	10
CDKG 4 HB	10108195	RAL 9005	3 - 4	20,7 x 20,7 mm	10
CDKG 5 HB	10108196	RAL 9005	4 - 5	20,7 x 20,7 mm	10
CDKG 6 HB	10108197	RAL 9005	5 - 6	20,7 x 20,7 mm	10
CDKG 7 HB	10108198	RAL 9005	6 - 7	20,7 x 20,7 mm	10
CDKG 8 HB	10108199	RAL 9005	7 - 8	20,7 x 20,7 mm	10
CDKG 9 HB	10108200	RAL 9005	8 - 9	20,7 x 20,7 mm	10
CDKG 10 HB	10108201	RAL 9005	9 - 10	20,7 x 20,7 mm	10
CDKG 11 HB	10108202	RAL 9005	10 - 11	20,7 x 20,7 mm	10
CDKG 12 HB	10108203	RAL 9005	11 - 12	20,7 x 20,7 mm	10
CDKG 13 HB	10108204	RAL 9005	12 - 13	20,7 x 20,7 mm	10
CDKG 14 HB	10108205	RAL 9005	13 - 14	20,7 x 20,7 mm	10
CDG 0 HB	10108206	RAL 9005	-	43,1 x 43,1 mm	10
CDGG 15 HB	10108207	RAL 9005	14 - 15	43,1 x 43,1 mm	10
CDGG 16 HB	10108208	RAL 9005	15 - 16	43,1 x 43,1 mm	10
CDGG 17 HB	10108209	RAL 9005	16 - 17	43,1 x 43,1 mm	10
CDGG 18 HB	10108210	RAL 9005	17 - 18	43,1 x 43,1 mm	10
CDGG 19 HB	10108211	RAL 9005	18 - 19	43,1 x 43,1 mm	10
CDGG 20 HB	10108212	RAL 9005	19 - 20	43,1 x 43,1 mm	10
CDGG 21 HB	10108213	RAL 9005	20 - 21	43,1 x 43,1 mm	10
CDGG 22 HB	10108214	RAL 9005	21 - 22	43,1 x 43,1 mm	10
CDGG 23 HB	10108215	RAL 9005	22 - 23	43,1 x 43,1 mm	10
CDGG 24 HB	10108216	RAL 9005	23 - 24	43,1 x 43,1 mm	10
CDGG 25 HB	10108217	RAL 9005	24 - 25	43,1 x 43,1 mm	10
CDGG 26 HB	10108218	RAL 9005	25 - 26	43,1 x 43,1 mm	10
CDGG 27 HB	10108219	RAL 9005	26 - 27	43,1 x 43,1 mm	10
CDGG 28 HB	10108220	RAL 9005	27 - 28	43,1 x 43,1 mm	10
CDGG 29 HB	10108221	RAL 9005	28 - 29	43,1 x 43,1 mm	10
CDGG 30 HB	10108222	RAL 9005	29 - 30	43,1 x 43,1 mm	10
CDGG 31 HB	10108223	RAL 9005	30 - 31	43,1 x 43,1 mm	10
CDGG 32 HB	10108224	RAL 9005	31 - 32	43,1 x 43,1 mm	10
CDGG 33 HB	10108225	RAL 9005	32 - 33	43,1 x 43,1 mm	10
CDKS 2-11 HB	10108226	RAL 9005	2 - 11	20,7 x 20,7 mm	10
CDGS 7-24 HB	10108227	RAL 9005	7 - 24	43,1 x 43,1 mm	10
CDKG 2x4-5 HB	10108228	RAL 9005	4 - 5	20,7 x 20,7 mm	10
CDKG 2x5-6 HB	10108229	RAL 9005	5 - 6	20,7 x 20,7 mm	10
CDKG 4x2-3 HB	10108230	RAL 9005	2 - 3	20,7 x 20,7 mm	10
CDKG 4x3-4 HB	10108231	RAL 9005	3 - 4	20,7 x 20,7 mm	10
CDKG/1xASI HB	10108232	RAL 9005	-	20,7 x 20,7 mm	10
CDKG/2xASI HB	10108233	RAL 9005	-	20,7 x 20,7 mm	10

Type	WISKA-No.	RAL-No.	 (mm)	BxL (mm)		
CDK 0 VO	10108234	RAL 7035	-	20,7 x 20,7 mm	10	PLÁSTICO
CDKG 2 VO	10108235	RAL 7035	1,5 - 2	20,7 x 20,7 mm	10	
CDKG 3 VO	10108236	RAL 7035	2 - 3	20,7 x 20,7 mm	10	
CDKG 4 VO	10108237	RAL 7035	3 - 4	20,7 x 20,7 mm	10	METAL
CDKG 5 VO	10108238	RAL 7035	4 - 5	20,7 x 20,7 mm	10	
CDKG 6 VO	10108239	RAL 7035	5 - 6	20,7 x 20,7 mm	10	
CDKG 7 VO	10108240	RAL 7035	6 - 7	20,7 x 20,7 mm	10	
CDKG 8 VO	10108241	RAL 7035	7 - 8	20,7 x 20,7 mm	10	MARÍTIMO
CDKG 9 VO	10108242	RAL 7035	8 - 9	20,7 x 20,7 mm	10	
CDKG 10 VO	10108243	RAL 7035	9 - 10	20,7 x 20,7 mm	10	
CDKG 11 VO	10108244	RAL 7035	10 - 11	20,7 x 20,7 mm	10	
CDKG 12 VO	10108245	RAL 7035	11 - 12	20,7 x 20,7 mm	10	
CDKG 13 VO	10108246	RAL 7035	12 - 13	20,7 x 20,7 mm	10	EMC
CDKG 14 VO	10108247	RAL 7035	13 - 14	20,7 x 20,7 mm	10	
CDG 0 VO	10108248	RAL 7035	-	43,1 x 43,1 mm	10	
CDGG 15 VO	10108249	RAL 7035	14 - 15	43,1 x 43,1 mm	10	EX E/I
CDGG 16 VO	10108250	RAL 7035	15 - 16	43,1 x 43,1 mm	10	
CDGG 17 VO	10108251	RAL 7035	16 - 17	43,1 x 43,1 mm	10	
CDGG 18 VO	10108252	RAL 7035	17 - 18	43,1 x 43,1 mm	10	
CDGG 19 VO	10108253	RAL 7035	18 - 19	43,1 x 43,1 mm	10	EX D
CDGG 20 VO	10108254	RAL 7035	19 - 20	43,1 x 43,1 mm	10	
CDGG 21 VO	10108255	RAL 7035	20 - 21	43,1 x 43,1 mm	10	
CDGG 22 VO	10108256	RAL 7035	21 - 22	43,1 x 43,1 mm	10	
CDGG 23 VO	10108257	RAL 7035	22 - 23	43,1 x 43,1 mm	10	FERROVIÁRIO
CDGG 24 VO	10108258	RAL 7035	23 - 24	43,1 x 43,1 mm	10	
CDGG 25 VO	10108259	RAL 7035	24 - 25	43,1 x 43,1 mm	10	
CDGG 26 VO	10108260	RAL 7035	25 - 26	43,1 x 43,1 mm	10	EQUALIZAÇ / VENTILAÇÃO
CDGG 27 VO	10108261	RAL 7035	26 - 27	43,1 x 43,1 mm	10	
CDGG 28 VO	10108262	RAL 7035	27 - 28	43,1 x 43,1 mm	10	
CDGG 29 VO	10108263	RAL 7035	28 - 29	43,1 x 43,1 mm	10	
CDGG 30 VO	10108264	RAL 7035	29 - 30	43,1 x 43,1 mm	10	PADRÃO BRITÂNICO
CDGG 31 VO	10108265	RAL 7035	30 - 31	43,1 x 43,1 mm	10	
CDGG 32 VO	10108266	RAL 7035	31 - 32	43,1 x 43,1 mm	10	
CDGG 33 VO	10108267	RAL 7035	32 - 33	43,1 x 43,1 mm	10	
CDKG 2x4-5 VO	10108268	RAL 7035	4 - 5	20,7 x 20,7 mm	10	VEDAÇÕES
CDKG 2x5-6 VO	10108269	RAL 7035	5 - 6	20,7 x 20,7 mm	10	
CDKG 4x2-3 VO	10108270	RAL 7035	2 - 3	20,7 x 20,7 mm	10	
CDKG 4x3-4 VO	10108271	RAL 7035	3 - 4	20,7 x 20,7 mm	10	
CDKG/1xASI VO	10108272	RAL 7035	-	20,7 x 20,7 mm	10	MEMBRANA
CDKG/2xASI VO	10108273	RAL 7035	-	20,7 x 20,7 mm	10	

CONMAXX® dividido prensa cabos inclusive contra porca, CKM, plástico, métrico

CKM

**Faixa de temperatura**

-40 °C - 100 °C

Classe de proteção

IP66

Material

Prensa Cabo de Poliamida UL94-V0, Vedação de TPE UL94-V0

Type	WISKA-No. RAL 7035				TL (mm)	
CKM 20 V0 LG	10108663	M 20x1,5	15	38	39	1
CKM 25 V0 LG	10108664	M 25x1,5	15	38	39	1
CKM 32 V0 LG	10108665	M 32x1,5	15	38	39	1
CKM 40 V0 LG	10108666	M 40x1,5	15	68	40	1
CKM 50 V0 LG	10108667	M 50x1,5	15	68	40	1
CKM 63 V0 LG	10108668	M 63x1,5	15	68	40	1

CONMAXX® contra porca dividida de fixação, CMM, plástico, métrico

CMM

**Faixa de temperatura**

-40 °C - 100 °C

Material

Poliamida UL94-V0

Type	WISKA-No. RAL 7035			TL (mm)	
CMM 20 V0 LG	10108675	M 20x1,5	28	5	5
CMM 25 V0 LG	10108676	M 25x1,5	33	6	5
CMM 32 V0 LG	10108677	M 32x1,5	40	6	5
CMM 40 V0 LG	10108678	M 40x1,5	48	7	1
CMM 50 V0 LG	10108679	M 50x1,5	58	7	1
CMM 63 V0 LG	10108680	M 63x1,5	72	7	1

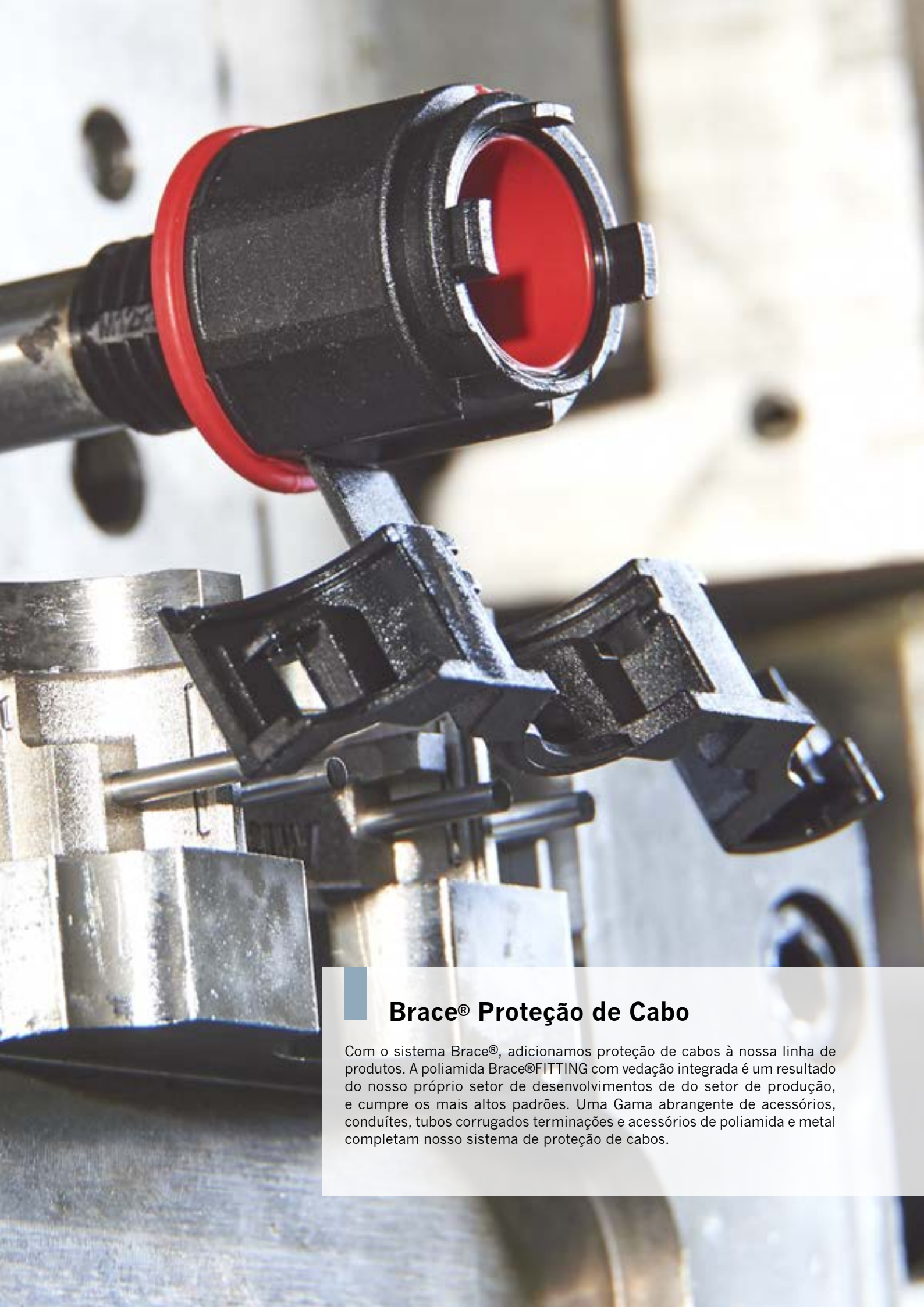

Brace® Proteção de Cabo

Com o sistema Brace®, adicionamos proteção de cabos à nossa linha de produtos. A poliamida Brace®FITTING com vedação integrada é um resultado do nosso próprio setor de desenvolvimentos de do setor de produção, e cumpre os mais altos padrões. Uma Gama abrangente de acessórios, conduítes, tubos corrugados terminações e acessórios de poliamida e metal completam nosso sistema de proteção de cabos.

BraceFITTING encaixe, EBFS, poliamida, métrica

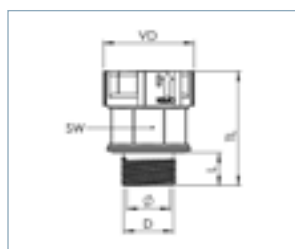





EBFS



Classe de proteção
Faixa de temperatura
Material

IP66 / IP68
-40 °C - 100 °C
Terminação de Poliamida UL94-V0, Rosca de conexão Poliamida UL94-V0, Vedação de TPU

Type	WISKA-No. RAL 7031	WISKA-No. RAL 9005	NW	 d (mm)	 (mm)	VD (mm)	\varnothing	 SW (mm)	TL (mm)	
EBFS-07-12	10106844	10106861	7	M 12x1,5	10	21,60	5,70	17	35,1	50
EBFS-10-12	10106845	10106862	10	M 12x1,5	10	24,80	7	20	38,3	50
EBFS-10-16	10106846	10106863	10	M 16x1,5	10	24,80	9	20	38,3	50
EBFS-12-16	10106847	10106864	12	M 16x1,5	10	27,50	11,5	22	37,2	50
EBFS-12-20	10106848	10106865	12	M 20x1,5	12	27,50	12	22	39,2	50
EBFS-14-20	10106849	10106866	14	M 20x1,5	12	30	12	25	42,1	50
EBFS-17-20	10106850	10106867	17	M 20x1,5	12	32,65	14,80	27	41,5	50
EBFS-17-25	10106851	10106868	17	M 25x1,5	12	32,65	15,50	27	41,5	50
EBFS-23-25	10106852	10106869	23	M 25x1,5	14	42	19	36	50,3	25
EBFS-23-32	10106853	10106870	23	M 32x1,5	14	47,30	19	36	50,3	25
EBFS-29-32	10106854	10106871	29	M 32x1,5	14	47,30	26	41	53	10
EBFS-29-40	10106855	10106872	29	M 40x1,5	14	47,30	26	41	53	10
EBFS-36-40	10106856	10106873	36	M 40x1,5	14	54,90	33,50	50	53,6	10
EBFS-36-50	10106857	10106874	36	M 50x1,5	15	54,90	33,50	50	55,1	10
EBFS-48-50	10106858	10106875	48	M 50x1,5	16	68	42,50	60	56,8	5
EBFS-48-63	10106859	10106876	48	M 63x1,5	16	68	44	60	56,8	5

Acessórios recomendados



Brace@CONDUIT
Tubos corrugados de plástico

BraceFITTING, EMBFS, poliamida e latão, métrico



EMBFS

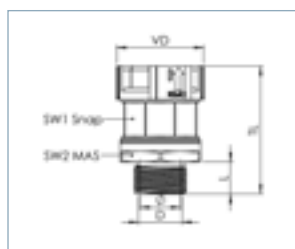

Classe de proteção
Faixa de temperatura
Material

IP66 / IP68
-40 °C - 100 °C
Terminação de Poliamida UL94-V0, Rosca de conexão Latão niquelado,
Vedação de TPU

Type	WISKA-No. RAL 7031	WISKA-No. RAL 9005	NW			VD (mm)				TL (mm)	
EMBFS-07-12	10106877	10106893	7	M 12x1,5	9,5	21,60	6	17	18	42,1	50
EMBFS-10-16	10106878	10106894	10	M 16x1,5	12	24,80	7	20	21	46,8	50
EMBFS-10-20	10106879	10106895	10	M 20x1,5	12	24,80	7	20	22	46,8	50
EMBFS-12-16	10106880	10106896	12	M 16x1,5	12	27,50	11,5	22	24	46,7	50
EMBFS-12-20	10106881	10106897	12	M 20x1,5	12	27,50	11,5	22	24	46,7	50
EMBFS-14-20	10106882	10106898	14	M 20x1,5	12	30	12	25	27	49	50
EMBFS-17-20	10106883	10106899	17	M 20x1,5	12	32,65	15,20	27	30	49	50
EMBFS-17-25	10106884	10106900	17	M 25x1,5	12	32,65	15,20	27	30	49	50
EMBFS-23-25	10106885	10106901	23	M 25x1,5	12	42	19	36	41	55,8	25
EMBFS-23-32	10106886	10106902	23	M 32x1,5	12	42	19	36	41	55,8	25
EMBFS-29-32	10106887	10106903	29	M 32x1,5	12	47,30	26	41	46	58,5	10
EMBFS-29-40	10106888	10106904	29	M 40x1,5	12	47,30	26	41	46	58,5	10
EMBFS-36-40	10106889	10106905	36	M 40x1,5	12	54,90	33,50	50	50	59,1	10
EMBFS-36-50	10106890	10106906	36	M 50x1,5	14	54,90	33,50	50	55	61,1	10
EMBFS-48-50	10106891	10106907	48	M 50x1,5	14	68	42,50	60	65	62,3	5
EMBFS-48-63	10106892	10106908	48	M 63x1,5	14	68	42,50	60	70	62,3	5

Acessórios recomendados



Brace@CONDUIT
Tubos corrugados de plástico

BraceFITTING com rosca interna, EMBFSI, poliamida e latão, métrica

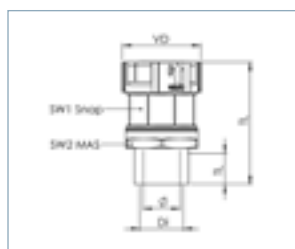

EMBFSI



Classe de proteção IP66 / IP68
Faixa de temperatura -40 °C - 100 °C
Material Terminação de Poliamida UL94-V0, Rosca de conexão Latão niquelado, Vedação de TPU

Type	WISKA-No. RAL 7031	WISKA-No. RAL 9005	NW			VD (mm)				TL (mm)	
EMBFSI-10-16	10106914	10106922	10	M 16x1,5	12	24,80	7	20	21	49,9	50
EMBFSI-12-16	10106915	10106923	12	M 16x1,5	12	27,50	11,60	22	24	48,8	50
EMBFSI-12-20	10106916	10106924	12	M 20x1,5	12	27,50	11,60	22	24	48,8	50
EMBFSI-17-20	10106917	10106925	17	M 20x1,5	12	32,70	15,40	27	30	51,2	50
EMBFSI-23-25	10106918	10106926	23	M 25x1,5	13	42	19	36	41	58,1	50
EMBFSI-29-32	10106919	10106927	29	M 32x1,5	13	47,30	26	41	46	60,9	25
EMBFSI-36-40	10106920	10106928	36	M 40x1,5	13	54,90	33,50	50	55	61,5	10
EMBFSI-48-50	10106921	10106929	48	M 50x1,5	13	68	42,50	60	65	62,7	5

Acessórios recomendados



BraceFITTING com prensa cabo, EMBFSCG, poliamida e latão, métrico

EMBFSCG

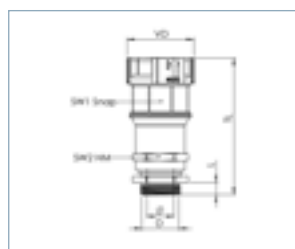

Classe de proteção
Faixa de temperatura
Material

IP66 / IP68
-40 °C - 100 °C
Terminação de Poliamida UL94-V0, Rosca de conexão Latão niquelado,
Vedação de TPU

Type	WISKA-No. RAL 7031	WISKA-No. RAL 9005	NW			VD (mm)				TL (mm)	
EMBFSCG-10-16	10107371	10107379	10	M 16x1,5	5	24,80	7	20	20	63,7 - 71,7	50
EMBFSCG-12-16	10107372	10107380	12	M 16x1,5	5	27,50	10	22	24	68 - 76	50
EMBFSCG-12-20	10107373	10107381	12	M 20x1,5	6	27,50	10	22	24	64,9 - 72,9	50
EMBFSCG-17-20	10107374	10107382	17	M 20x1,5	6	32,70	13	27	24	66,4 - 74,4	50
EMBFSCG-23-25	10107375	10107383	23	M 25x1,5	7	42	17	36	29	76,8 - 85,8	25
EMBFSCG-29-32	10107376	10107384	29	M 32x1,5	8	47,30	21	41	36	82,2 - 90,2	25
EMBFSCG-36-40	10107377	10107385	36	M 40x1,5	8	54,90	28	50	46	91,3 - 102,3	5
EMBFSCG-48-50	10107378	10107386	48	M 50x1,5	9	68	35	60	55	98,5 - 109,5	5

Acessórios recomendados

PLÁSTICO

METAL

MARÍTIMO

EMC

EX E/I

EX D

FERROVIÁRIO

 EQUALIZAÇ/
VENTILAÇÃO

 PADRÃO
BRITÂNICO

VEDAÇÕES

MEMBRANA

CONMAXX

 CONMAXX
GLAND

 BRACE
FITTING
PLÁSTICO

 BRACE
CONDUIT
PLÁSTICO

 BRACE
FITTING
METAL

 BRACE
CONDUIT
METAL

BraceFITTING ângulo de 45 °, EBF45, poliamida, métrica

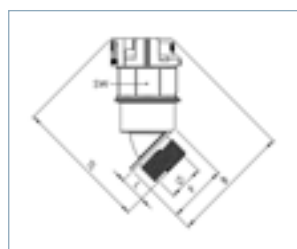





EBF45-BK



Classe de proteção
Faixa de temperatura
Material

IP66 / IP68
-40 °C - 100 °C
Terminação de Poliamida UL94-V0, Vedação de TPU

Type	WISKA-No. RAL 7031	WISKA-No. RAL 9005	NW	 D (mm)	 L (mm)	 Ø	B (mm)	 SW (mm)	TL (mm)	
EBF45-07-12	10106948	10106956	7	M 12x1,5	9	6	44,8	17	47,2	50
EBF45-10-12	10108870	10108876	10	M 12x1,5	9	7	48,3	20	50,6	50
EBF45-10-16	10106949	10106957	10	M 16x1,5	12	9	51,2	20	53,2	50
EBF45-12-16	10106950	10106958	12	M 16x1,5	12	10,70	51,4	22	53,4	50
EBF45-12-20	10108871	10108877	12	M 20x1,5	12	12	55,1	22	57,2	50
EBF45-17-20	10106951	10106959	17	M 20x1,5	12	13,20	58,7	27	60,8	50
EBF45-17-25	10108872	10108878	17	M 25x1,5	13	15,50	63,3	27	65,1	50
EBF45-23-25	10106952	10106960	23	M 25x1,5	13	18,20	71,6	36	73,4	25
EBF45-23-32	10108873	10108879	23	M 32x1,5	13	19	77,8	36	76,3	25
EBF45-29-32	10106953	10106961	29	M 32x1,5	13	26	81,5	41	80	25
EBF45-29-40	10108874	10108880	29	M 40x1,5	14,5	26	87,2	41	85,8	25
EBF45-36-40	10106954	10106962	36	M 40x1,5	14,5	33,50	90,8	50	89,5	10
EBF45-36-50	10108875	10108881	36	M 50x1,5	16	33,50	98,4	50	95,9	10
EBF45-48-50	10106955	10106963	48	M 50x1,5	16	42,50	103,3	60	100,8	5
EBF45-48-63	10108882	10108883	48	M 63x1,5	17,5	44	110,8	60	104,3	5

Acessórios recomendados



Brace@CONDUIT
Tubos corrugados de plástico

BraceFITTING ângulo de 45 °, EMBF45, poliamida e latão, métrica



EMBF45

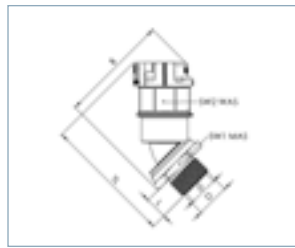

Classe de proteção
Faixa de temperatura
Material

IP66 / IP68
-40 °C - 100 °C
Terminação de Poliamida UL94-V0, Rosca de conexão Latão niquelado,
Vedação de TPU

Type	WISKA-No. RAL 7031	WISKA-No. RAL 9005	NW				B (mm)			TL (mm)	
EMBF45-07-12	10106982	10107318	7	M 12x1,5	9	6	45,8	18	17	55,7	50
EMBF45-10-12	10106983	10107319	10	M 12x1,5	12	7	50,5	20	20	62,1	50
EMBF45-10-16	10106984	10107320	10	M 16x1,5	12	7	51,4	22	20	62	50
EMBF45-12-16	10106985	10107321	12	M 16x1,5	12	10,70	53,2	23	22	63,8	50
EMBF45-12-20	10106986	10107322	12	M 20x1,5	12	10,70	53,3	23	22	63,8	50
EMBF45-17-20	10106987	10107323	17	M 20x1,5	12	13,20	62	30	27	69,4	50
EMBF45-17-25	10106988	10107324	17	M 25x1,5	12	13,20	62,2	30	27	69,3	50
EMBF45-23-25	10106989	10107325	23	M 25x1,5	12	18,20	75,6	36	36	80,9	25
EMBF45-23-32	10106990	10107326	23	M 32x1,5	12	18,20	75,6	36	36	81,9	25
EMBF45-29-32	10106991	10107327	29	M 32x1,5	12	26	86,8	46	41	88,5	25
EMBF45-29-40	10106992	10107328	29	M 40x1,5	12	26	86,1	46	41	87,5	25
EMBF45-36-40	10106993	10107329	36	M 40x1,5	12	33,50	93,8	50	50	96,5	10
EMBF45-36-50	10106994	10107330	36	M 50x1,5	14	33,50	96,6	50	50	98,5	10
EMBF45-48-50	10106995	10107331	48	M 50x1,5	14	42,50	110,3	65	60	107,9	5
EMBF45-48-63	10106996	10107332	48	M 63x1,5	14	42,50	113	70	60	108,3	5

Acessórios recomendados



BraceFITTING ângulo de 45 ° com rosca interna, EMBF45I, poliamida e latão, métrico





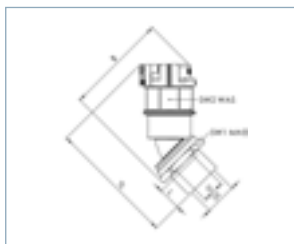



EMBF45I



Classe de proteção
Faixa de temperatura
Material

IP66 / IP68
-40 °C - 100 °C
Terminação de Poliamida UL94-V0, Rosca de conexão Latão niquelado,
Vedação de TPU

Type	WISKA-No. RAL 7031	WISKA-No. RAL 9005	NW	 D (mm)	 H (mm)	 Ø	B (mm)	 SW 1 (mm)	 SW 2 (mm)	TL (mm)	
EMBF45I-12-16	10107333	10107340	12	M 16x1,5	12	10	55,3	24	22	70,5	50
EMBF45I-12-20	10107334	10107341	12	M 20x1,5	13	10	55,3	24	22	70,5	50
EMBF45I-17-20	10107335	10107342	17	M 20x1,5	13	15,50	62,3	30	27	72	50
EMBF45I-23-25	10107336	10107343	23	M 25x1,5	13	18	75,8	36	36	88,5	50
EMBF45I-29-32	10107337	10107344	29	M 32x1,5	13	26	87,3	46	41	94	25
EMBF45I-36-40	10107338	10107345	36	M 40x1,5	13	33	97,3	55	50	102,7	10
EMBF45I-48-50	10107339	10107346	48	M 50x1,5	13	42	111,2	65	60	114,2	10

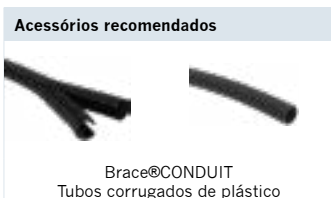

BraceFITTING ângulo de 45 ° com prensa cabo, EMBF45CG, poliamida e latão, métrico

EMBF45CG

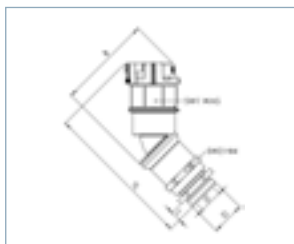

Classe de proteção
Faixa de temperatura
Material

IP66 / IP68
-40 °C - 100 °C
Terminação de Poliamida UL94-V0, Rosca de conexão Latão niquelado,
Vedação de TPU

Type	WISKA-No. RAL 7031	WISKA-No. RAL 9005	NW	D (mm)	VD (mm)	∅	B (mm)	SW 1 (mm)	SW 2 (mm)	TL (mm)		
EMBF45CG-12-16	10107987	10107993	12	M 16x1,5	5	25	10	55,3	22	24	90,2 - 98,2	50
EMBF45CG-17-20	10107988	10107994	17	M 20x1,5	6	30,40	13	60,7	27	24	89,8 - 97,8	50
EMBF45CG-23-25	10107989	10107995	23	M 25x1,5	7	39,40	17	71,8	36	29	107,9 - 116,9	25
EMBF45CG-29-32	10107990	10107996	29	M 32x1,5	8	44,40	21	82	41	36	116,8 - 124,8	25
EMBF45CG-36-40	10107991	10107997	36	M 40x1,5	8	53,40	28	92,1	50	46	132,6 - 143,6	5
EMBF45CG-48-50	10107992	10107998	48	M 50x1,5	9	65,80	35	105,2	60	55	150,8 - 161,8	5

Acessórios recomendados

Brace@CONDUIT
Tubos corrugados de plástico

PLÁSTICO

METAL

MARÍTIMO

EMC

EX E/I

EX D

FERROVIÁRIO

 EQUALIZAÇ/
VENTILAÇÃO

 PADRÃO
BRITÂNICO

VEDAÇÕES

MEMBRANA

CONMAXX

 CONMAXX
GLAND

 BRACE
FITTING
PLÁSTICO

 BRACE
CONDUIT
PLÁSTICO

 BRACE
FITTING
METAL

 BRACE
CONDUIT
METAL

BraceFITTING ângulo de 90 °, EBF90, poliamida, métrica

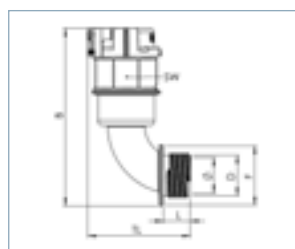





EBF90



Classe de proteção
Faixa de temperatura
Material

IP66 / IP68
-40 °C - 100 °C
Terminação de Poliamida UL94-V0, Vedação de TPU

Type	WISKA-No. RAL 7031	WISKA-No. RAL 9005	NW	 D (mm)	 L (mm)	 Ø	B (mm)	 SW (mm)	TL (mm)	
EBF90-07-12	10106966	10106974	7	M 12x1,5	9	6	64,8	17	32	50
EBF90-10-12	10108884	10108891	10	M 12x1,5	9	7	68	20	33,6	50
EBF90-10-16	10106967	10106975	10	M 16x1,5	10,5	9	71,9	20	36,7	50
EBF90-12-16	10106968	10106976	12	M 16x1,5	10,5	10,50	71,9	22	36,7	50
EBF90-12-20	10108885	10108892	12	M 20x1,5	12	13	76,3	22	40,8	50
EBF90-17-20	10106969	10106977	17	M 20x1,5	12	13	78,6	27	43,5	50
EBF90-17-25	10108886	10108893	17	M 25x1,5	13	15,50	85,1	27	50	50
EBF90-23-25	10106970	10106978	23	M 25x1,5	13	19	92,4	36	51,5	25
EBF90-23-32	10108887	10108894	23	M 32x1,5	13	19	100,9	36	55,5	25
EBF90-29-32	10106971	10106979	29	M 32x1,5	13	26	103,6	41	58	25
EBF90-29-40	10108888	10108895	29	M 40x1,5	14,5	26	118,8	41	69,3	25
EBF90-36-40	10106972	10106980	36	M 40x1,5	14,5	33,50	119,4	50	74,8	10
EBF90-36-50	10108889	10108896	36	M 50x1,5	16	33,50	130,9	50	79,8	10
EBF90-48-50	10106973	10106981	48	M 50x1,5	16	42,50	131,6	60	86	5
EBF90-48-63	10108890	10108897	48	M 63x1,5	17,5	44	140,9	60	90,2	5

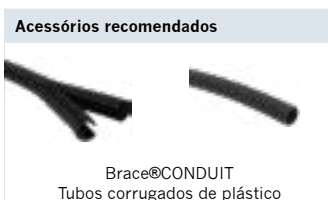

BraceFITTING ângulo de 90°, EMBF90, poliamida e latão, métrica



EMBF90

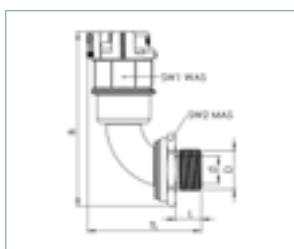

Classe de proteção
Faixa de temperatura
Material

IP66 / IP68
-40 °C - 100 °C
Terminação de Poliamida UL94-V0, Rosca de conexão Latão niquelado,
Vedação de TPU

Type	WISKA-No. RAL 9005	WISKA-No. RAL 7031	NW				B (mm)			TL (mm)	
EMBF90-07-12	10107013	10106998	7	M 12x1,5	9	6	65,6	18	17	40,4	50
EMBF90-10-12	10107014	10106999	10	M 12x1,5	12	7	70,1	20	20	44	50
EMBF90-10-16	10107015	10107000	10	M 16x1,5	12	7	71,1	22	20	44	50
EMBF90-12-16	10107016	10107001	12	M 16x1,5	12	10	72,7	23	22	48,1	50
EMBF90-12-20	10107017	10107002	12	M 20x1,5	12	10	72,7	23	22	48,1	50
EMBF90-17-20	10107018	10107003	17	M 20x1,5	12	13	82	30	27	52	50
EMBF90-17-25	10107019	10107004	17	M 25x1,5	12	13	82	30	27	52	50
EMBF90-23-25	10107020	10107005	23	M 25x1,5	12	18	96,2	36	36	58,9	25
EMBF90-23-32	10107021	10107006	23	M 32x1,5	12	18	96,2	36	36	59,9	25
EMBF90-29-32	10107022	10107007	29	M 32x1,5	12	26	108,5	46	41	65,9	25
EMBF90-29-40	10107023	10107008	29	M 40x1,5	12	26	108,7	46	41	65,9	25
EMBF90-36-40	10107024	10107009	36	M 40x1,5	12	33	122,2	50	50	80,7	10
EMBF90-36-50	10107025	10107010	36	M 50x1,5	14	33	125	55	50	82,7	10
EMBF90-48-50	10107026	10107011	48	M 50x1,5	14	42	138,4	65	60	93,4	5
EMBF90-48-63	10107027	10107012	48	M 63x1,5	14	42	141,1	70	60	93,4	5

Acessórios recomendados



Brace@CONDUIT
Tubos corrugados de plástico

PLÁSTICO

METAL

MARÍTIMO

EMC

EX E/I

EX D

FERROVIÁRIO

EQUILIBRAÇÃO /
VENTILAÇÃOPADRÃO
BRITÂNICO

VEDAÇÕES

MEMBRANA

CONMAXX

CONMAXX
GLANDBRACE
FITTING
PLÁSTICOBRACE
CONDUIT
PLÁSTICOBRACE
FITTING
METALBRACE
CONDUIT
METAL

BraceFITTING ângulo de 90 ° com rosca interna, EMBF90I, poliamida e latão, métrica

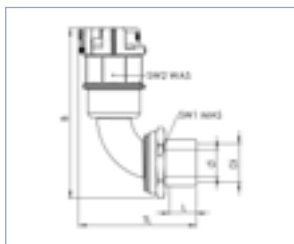

EMBF90I



Classe de proteção
Faixa de temperatura
Material

IP66 / IP68
-40 °C - 100 °C
Terminação de Poliamida UL94-V0, Rosca de conexão Latão niquelado,
Vedação de TPU

Type	WISKA-No. RAL 7031	WISKA-No. RAL 9005	NW				B (mm)			TL (mm)	
EMBF90I-10-16	10107354	10107363	10	M 16x1,5	13	7	67,7	22	20	45,9	50
EMBF90I-12-16	10107355	10107364	12	M 16x1,5	13	10	72,9	24	22	54,1	50
EMBF90I-12-20	10107356	10107365	12	M 20x1,5	13	10	72,9	24	22	54,1	50
EMBF90I-17-20	10107357	10107366	17	M 20x1,5	13	13	79,6	30	27	59,4	50
EMBF90I-23-25	10107359	10107367	23	M 25x1,5	13	18	95,7	36	36	68,7	50
EMBF90I-29-32	10107360	10107368	29	M 32x1,5	13	26	111,7	46	41	74,5	25
EMBF90I-36-40	10107361	10107369	36	M 40x1,5	13	33	120,8	55	50	85,2	10
EMBF90I-48-50	10107362	10107370	48	M 50x1,5	14	42	136,3	65	60	109,6	10

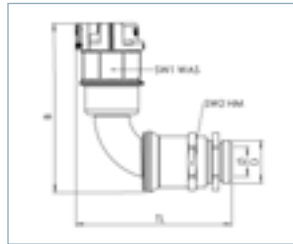

BraceFITTING ângulo de 90 ° com prensa cabo, EMBF90CG, poliamida e latão, métrica

EMBF90CG



Classe de proteção
Faixa de temperatura
Material

IP66 / IP68
-40 °C - 100 °C
Terminação de Poliamida UL94-V0, Rosca de conexão Latão niquelado,
Vedação de TPU

Type	WISKA-No. RAL 7031	WISKA-No. RAL 9005	NW	D (mm)	t (mm)	VD (mm)	Ø	B (mm)	SW 1 (mm)	SW 2 (mm)	TL (mm)	
EMBF90CG-10-16	10107999	10108006	10	M 16x1,5	5	22,30	7	66,5	20	20	72,1 · 80,1	50
EMBF90CG-12-16	10108000	10108007	12	M 16x1,5	5	25	10	74	22	24	73,8 · 81,8	50
EMBF90CG-17-20	10108001	10108008	17	M 20x1,5	6	30,40	13	79,8	27	24	75,3 · 83,3	50
EMBF90CG-23-25	10108002	10108009	23	M 25x1,5	7	39,40	17	91,7	36	29	88,2 · 97,2	25
EMBF90CG-29-32	10108003	10108010	29	M 32x1,5	8	44,40	21	109	41	36	106,3 · 114,3	25
EMBF90CG-36-40	10108004	10108011	36	M 40x1,5	8	53,40	28	118,1	50	46	115,2 · 126,2	5
EMBF90CG-48-50	10108005	10108012	48	M 50x1,5	9	65,80	35	133,2	60	55	135,9 · 146,9	5

Acessórios recomendados

BraceCONDUIT, BCA-S, poliamida PA6 V0



BCA-BG



Faixa de temperatura
Material

-40 °C - 140 °C
PA6 UL94-V0

Type	WISKA-No. RAL 7031	WISKA-No. RAL 9005	NW	ED (mm)	∅					
BCA-S-10	10107079	10107072	10	13	9,90	2,7	1,8	26	0,3	50 m
BCA-S-12	10107080	10107073	12	15,7	12,20	3,1	2,2	38	0,3	50 m
BCA-S-14	10107081	10107074	14	18,5	14,20	3,3	2,3	50	0,3	50 m
BCA-S-17	10107082	10107075	17	21,2	16,60	3,3	2,3	56	0,3	50 m
BCA-S-23	10107083	10107076	23	28,3	23,20	3,4	2,3	64	0,4	50 m
BCA-S-29	10107084	10107077	29	34,5	29	3,4	2,3	77	0,4	25 m
BCA-S-36	10107085	10107078	36	42,2	36	4,2	2,8	91	0,4	25 m

Acessórios recomendados



BraceCONDUIT, BCAV-S, poliamida PA6 V2



BCA-BG

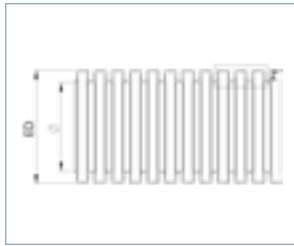

Faixa de temperatura -40 °C - 125 °C
Material PA6 UL94-V2

Type	WISKA-No. RAL 7031	WISKA-No. RAL 9005	NW	ED (mm)	Ø	A	B	Radius	S (mm)	Length
BCAV-S-07	10107095	10107086	7	10	6,70	2,7	1,8	24	0,2	50 m
BCAV-S-10	10107096	10107087	10	13	9,90	2,7	1,8	26	0,2	50 m
BCAV-S-12	10107097	10107088	12	15,7	12,20	3,1	2,2	38	0,3	50 m
BCAV-S-14	10107098	10107089	14	18,5	14,20	3,3	2,3	50	0,3	50 m
BCAV-S-17	10107099	10107090	17	21,2	16,60	3,3	2,3	56	0,3	50 m
BCAV-S-23	10107100	10107091	23	28,3	23,20	3,4	2,3	64	0,4	50 m
BCAV-S-29	10107101	10107092	29	34,5	29	3,4	2,3	77	0,4	25 m
BCAV-S-36	10107102	10107093	36	42,4	36	4,2	2,8	91	0,4	25 m
BCAV-S-48	10107103	10107094	48	54,5	47,70	4,3	2,8	117	0,4	25 m

Acessórios recomendados

BraceFITTING de plástico e plástico / metal

- PLÁSTICO
- METAL
- MARITIM
- EMC
- EX E/I
- EX D
- FERROVIÁRIO
- EQUALIZAC / VENTILAÇÃO
- PADRÃO BRITÂNICO
- VEDAÇÕES
- MEMBRANA
- CONMAXX
- CONMAXX GLAND
- BRACE FITTING PLÁSTICO
- BRACE CONDUIT PLÁSTICO
- BRACE FITTING METAL
- BRACE CONDUIT METAL

BraceCONDUIT, BCAB-L, poliamida PA6 HB, leve



BCA-BG

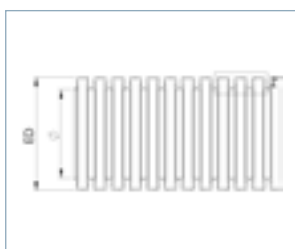

Faixa de temperatura
Material

-40 °C - 140 °C
PA6 UL94-HB

Type	WISKA-No. RAL 7031	WISKA-No. RAL 9005	NW	ED (mm)	∅	A	B	∠	S ₁₀ (mm)	50m
BCAB-L-07	10109190	10109181	7	10	6,80	2,7	1,8		0,2	50 m
BCAB-L-10	10109191	10109182	10	13	10	2,7	1,8	20	0,3	50 m
BCAB-L-12	10109192	10109183	12	15,7	12,40	3,1	2,2	25	0,3	50 m
BCAB-L-14	10109193	10109184	14	18,5	14,40	3,3	2,3		0,3	50 m
BCAB-L-17	10109194	10109185	17	21,2	16,80	3,3	2,3	50	0,3	50 m
BCAB-L-23	10109195	10109186	23	28,3	23,40	3,4	2,3	60	0,3	50 m
BCAB-L-29	10109196	10109187	29	34,5	29,20	3,4	2,3	70	0,4	25 m
BCAB-L-36	10109197	10109188	36	42,4	36,20	4,2	2,8	80	0,4	25 m
BCAB-L-48	10109198	10109189	48	54,5	47,90	4,3	2,8	95	0,4	25 m

Acessórios recomendados



BraceFITTING de plástico e plástico / metal

BraceCONDUIT, BCAV-H, poliamida PA6 V2, peso pesado



BCA-BG

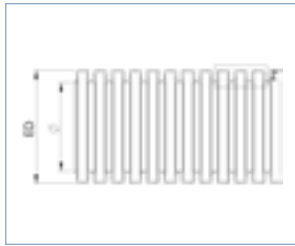

Faixa de temperatura -40 °C - 125 °C
Material PA6 UL94-V2

Type	WISKA-No. RAL 7031	WISKA-No. RAL 9005	NW	ED (mm)	∅	A	B	∠	S (mm)	Length
BCAV-H-07	10109207	10109199	7	10	6,40	2,7	1,8	23	0,4	50 m
BCAV-H-10	10109208	10109200	10	13	9	2,7	1,8	36	0,4	50 m
BCAV-H-12	10109209	10109201	12	15,8	11	3,1	2,2	48	0,4	50 m
BCAV-H-17	10109210	10109202	17	21	15,30	3,3	2,3	55	0,5	50 m
BCAV-H-23	10109211	10109203	23	28,5	21,60	3,4	2,3	65	0,5	50 m
BCAV-H-29	10109212	10109204	29	34,5	27,50	3,4	2,3	77	0,7	25 m
BCAV-H-36	10109213	10109205	36	42,5	35	4,2	2,8	96	0,7	25 m
BCAV-H-48	10109214	10109206	48	54,5	45,50	4,3	2,8	112	0,7	25 m

Acessórios recomendados

BraceFITTING de plástico e plástico / metal

- PLÁSTICO
- METAL
- MARITIM
- EMC
- EX E/I
- EX D
- FERROVIÁRIO
- EQUALIZAC / VENTILACAO
- PADRÃO BRITÂNICO
- VEDAÇÕES
- MEMBRANA
- CONMAXX
- CONMAXX GLAND
- BRACE FITTING PLÁSTICO
- BRACE CONDUIT PLÁSTICO
- BRACE FITTING METAL
- BRACE CONDUIT METAL

BraceCONDUIT, BCA-D, poliamida PA6 V0, dividida

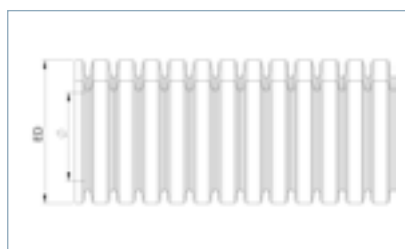

BCA-D



Faixa de temperatura
Material

-40 °C - 140 °C
PA6 UL94-V0

Type	WISKA-No. RAL 7031	WISKA-No. RAL 9005	NW	ED (mm)	Ø					
BCA-10-D	10107127	10107120	10	12,9	7,90	4	2,9	60	0,5	50 m
BCA-12-D	10107128	10107121	12	15,8	10,70	3,1	2	75	0,6	50 m
BCA-17-D	10107129	10107122	17	21	14,30	4,3	2,9	85	0,6	50 m
BCA-23-D	10107130	10107123	23	28,3	20,50	5,1	3,4	130	0,8	50 m
BCA-29-D	10107131	10107124	29	34,5	26,60	5,1	3,3	140	0,8	25 m
BCA-36-D	10107132	10107125	36	42,6	33,90	6,2	4,2	160	0,8	25 m
BCA-48-D	10107133	10107126	48	54,4	45,10	6,2	4,2	170	0,8	25 m

Acessórios recomendados



BraceCONDUIT, BCAV-D, poliamida PA6 V2, dividida



BCAV-D

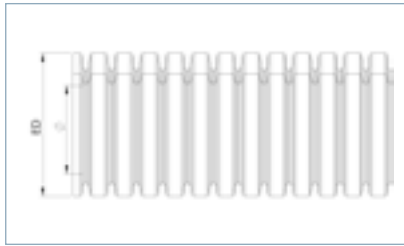

Faixa de temperatura -40 °C - 125 °C
Material PA6 UL94-V2

Type	WISKA-No. RAL 7031	WISKA-No. RAL 9005	NW	ED (mm)	∅	A	B	∠	S (mm)	Box
BCAV-10-D	10107141	10107134	10	12,9	7,90	4	2,9	60	0,5	50 m
BCAV-12-D	10107142	10107135	12	15,8	10,70	3,1	2	75	0,6	50 m
BCAV-17-D	10107143	10107136	17	21	14,30	4,3	2,9	85	0,6	50 m
BCAV-23-D	10107144	10107137	23	28,3	20,50	5,1	3,4	130	0,8	50 m
BCAV-29-D	10107145	10107138	29	34,5	26,60	5,1	3,3	140	0,8	25 m
BCAV-36-D	10107146	10107139	36	42,6	33,90	6,2	4,2	160	0,8	25 m
BCAV-48-D	10107147	10107140	48	54,4	45,10	6,2	4,2	170	0,8	25 m

Acessórios recomendados

BraceFITTING de plástico e plástico / metal

- PLÁSTICO
- METAL
- MARÍTIMO
- EMC
- EX E/I
- EX D
- FERROVIÁRIO
- EQUALIZAÇÃO / VENTILAÇÃO
- PADRÃO BRITÂNICO
- VEDAÇÕES
- MEMBRANA
- CONMAXX
- CONMAXX GLAND
- BRACE FITTING PLÁSTICO
- BRACE CONDUIT PLÁSTICO
- BRACE FITTING METAL
- BRACE CONDUIT METAL

BraceCONDUIT, BCI-S, poliamida PA12 V1



BCA-BG

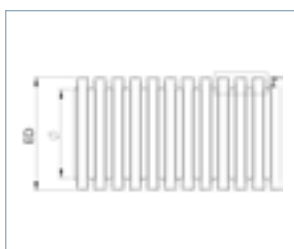

Faixa de temperatura
Material

-50 °C - 110 °C
WISKAmid PA12 V1 RW

Type	WISKA-No. RAL 9005	NW	ED (mm)	∅					
BCI-S-07	10109948	7	10	6,70	2,7	1,8	15	0,2	50 m
BCI-S-10	10109949	10	13	9,80	2,7	1,8	21	0,2	50 m
BCI-S-12	10109950	12	15,8	12	3,1	2,2	28	0,3	50 m
BCI-S-17	10109951	17	21	15,80	3,3	2,3	36	0,3	50 m
BCI-S-23	10109952	23	28,5	22	3,4	3,4	49	0,4	50 m
BCI-S-29	10109953	29	34,5	28,90	3,4	3,4	67	0,4	25 m
BCI-S-36	10109954	36	42,3	36	4,2	2,8	81	0,4	25 m
BCI-S-48	10109955	48	54,2	47,50	4,2	2,8	102	0,5	25 m

Accessórios recomendados



BraceCONDUIT, BCI-H-W, poliamida PA12 V1, peso pesado



BCA-BG

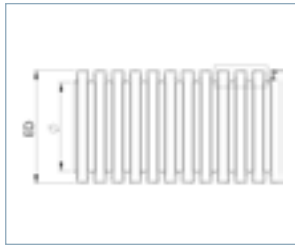

Faixa de temperatura -50 °C - 110 °C
Material WISKAmid PA12 V1 RW

Type	WISKA-No. RAL 9005	NW	ED (mm)	∅	A	B	∠	S (mm)	Image of box
BCI-H-07	10109964	7	10	6,50	2,7	1,8	15	0,3	50 m
BCI-H-10-W	10109965	10	13	9,60	2,7	1,8	21	0,4	50 m
BCI-H-12-W	10109966	12	15,8	11,80	3,1	2,2	28	0,4	50 m
BCI-H-17-W	10109967	17	21	16,60	3,3	2,3	36	0,4	50 m
BCI-H-23-W	10109968	23	28,5	22,70	3,4	2,3	49	0,4	50 m
BCI-H-29-W	10109969	29	34,5	28,70	3,4	2,3	67	0,5	25 m
BCI-H-36-W	10109970	36	42,2	35	4,2	2,8	81	0,5	25 m
BCI-H-48-W	10109971	48	54,5	46,30	4,3	2,8	102	0,6	25 m

Accesórios recomendados

BraceFITTING de plástico e plástico / metal

- PLÁSTICO
- METAL
- MARÍTIMO
- EMC
- EX E/I
- EX D
- FERROVIÁRIO
- EQUALIZAC / VENTILACAO
- PADRÃO BRITÂNICO
- VEDAÇÕES
- MEMBRANA
- CONMAXX
- CONMAXX GLAND
- BRACE FITTING PLÁSTICO
- BRACE CONDUIT PLÁSTICO
- BRACE FITTING METAL
- BRACE CONDUIT METAL

BraceCONDUIT, BCIV-S, poliamida PA12 V2



BCA-BG

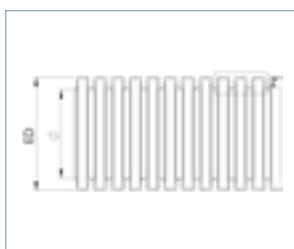

Faixa de temperatura
Material

-40 °C - 110 °C
PA12 UL94-V2

Type	WISKA-No. RAL 7031	WISKA-No. RAL 9005	NW	ED (mm)	∅					
BCIV-S-10	10107112	10107104	10	13	9,80	2,7	1,8	21	0,2	50 m
BCIV-S-12	10107113	10107105	12	15,8	12	3,1	2,2	28	0,3	50 m
BCIV-S-14	10107114	10107106	14	18,5	14,20	3,3	2,9	34	0,3	50 m
BCIV-S-17	10107115	10107107	17	21	15,80	3,3	2,3	36	0,3	50 m
BCIV-S-23	10107116	10107108	23	28,5	22	3,4	3,4	49	0,4	50 m
BCIV-S-29	10107117	10107109	29	34,5	28,90	3,4	3,4	67	0,4	25 m
BCIV-S-36	10107118	10107110	36	42,3	36	4,2	2,8	81	0,4	25 m
BCIV-S-48	10107119	10107111	48	54,2	47,50	4,2	2,8	102	0,4	25 m

Acessórios recomendados



BraceCONDUIT, BCIB-H, poliamida PA12 HB, peso pesado



BCA-BG

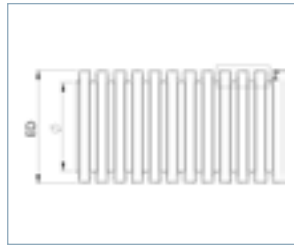

Faixa de temperatura
Material

-40° C - 120 °C
PA12 UL94-HB

Type	WISKA-No. RAL 7031	WISKA-No. RAL 9005	NW	ED (mm)	∅					
BCIB-H-07	10109229	10109220	7	10	6,80	2,7	1,8	15	0,3	50 m
BCIB-H-10	10109230	10109221	10	13	9,80	2,7	1,8	21	0,4	50 m
BCIB-H-12	10109231	10109222	12	15,8	12	3,1	2,2	28	0,4	50 m
BCIB-H-14	10109232	10109223	14	18,5	14,20	3,3	2,9	34	0,4	50 m
BCIB-H-17	10109233	10109224	17	21	16,80	3,3	2,3	36	0,4	50 m
BCIB-H-23	10109234	10109225	23	28,5	22,90	3,4	2,3	49	0,6	50 m
BCIB-H-29	10109235	10109226	29	34,5	28,90	3,4	3,4	67	0,6	25 m
BCIB-H-36	10109236	10109227	36	42,5	35,20	4,2	4,1	81	0,7	25 m
BCIB-H-48	10109237	10109228	48	54,5	46,50	4,3	4,1	102	0,7	25 m

Acessórios recomendados



BraceFITTING de plástico e plástico / metal

BraceCONDUIT Clip, BCC, poliamida



BCC



Faixa de temperatura
Material

-40 °C - 100 °C
Poliamida UL94-V0

Type	WISKA-No. RAL 7031	WISKA-No. RAL 9005	NW	B 	H (mm) 	M 	TL (mm) 	
BCC-07	10106930	10106939	7	20	22,5	M4	17	50
BCC-10	10106931	10106940	10	20	25	M5	22	50
BCC-12	10106932	10106941	12	20	29	M5	26	50
BCC-14	10106933	10106942	14	20	31,5	M5	27	50
BCC-17	10106934	10106943	17	20	34,8	M5	29,5	50
BCC-23	10106935	10106944	23	20	43,5	M6	39	25
BCC-29	10106936	10106945	29	20	49,5	M6	45	10
BCC-36	10106937	10106946	36	20	59	M6	54	10
BCC-48	10106938	10106947	48	20	74	M6	68	5

Encaixe da canalização de BraceFITTING, EMBMFS, bronze, métrico



EMBMFS-S



EMBMFS-C



Classe de proteção
Faixa de temperatura
Material

IP67
-45 °C - 145 °C
Terminação de Latão níquelado, Vedação de PA

EMBMFS-S

Type	WISKA-No.	NW						VD (mm)	TL (mm)	Para mangueira de proteção	
EMBMFS-S-10-12	10109087	10	M 12x1,5	9	10	20	22	24	33,5	liso	5
EMBMFS-S-10-16	10109089	10	M 16x1,5	9	10	20	22	24	33,5	liso	5
EMBMFS-S-12-16	10109091	12	M 16x1,5	9	12	24	26	29	33,5	liso	5
EMBMFS-S-12-20	10109093	12	M 20x1,5	9	12	24	26	29	33,5	liso	5
EMBMFS-S-16-16	10109095	16	M 16x1,5	9	15,50	27	29	33	33,5	liso	5
EMBMFS-S-16-20	10109097	16	M 20x1,5	9	15,50	27	29	33	33,5	liso	5
EMBMFS-S-16-25	10109099	16	M 25x1,5	9	15,50	27	29	33	33,5	liso	5
EMBMFS-S-21-20	10109101	21	M 20x1,5	9	20,50	33	35	33	36,2	liso	5
EMBMFS-S-21-25	10109103	21	M 25x1,5	9	20,50	33	35	33	36,8	liso	5

EMBMFS-S

Type	WISKA-No.	NW						VD (mm)	TL (mm)	Para mangueira de proteção	
EMBMFS-S-27-25	10109105	27	M 25x1,5	11	26,50	43	45	49	46,4	liso	5
EMBMFS-S-27-32	10109107	27	M 32x1,5	11	26,50	43	45	49	46,4	liso	2
EMBMFS-S-27-40	10109109	27	M 40x1,5	11	26,50	43	45	49	46,2	liso	2
EMBMFS-S-35-40	10109111	35	M 40x1,5	11	34,50	52	54	60	46,8	liso	2
EMBMFS-S-40-40	10109113	40	M 40x1,5	14	39,50	60	62	69	52,3	liso	2
EMBMFS-S-40-50	10109115	40	M 50x1,5	14	39,50	60	62	69	54,5	liso	2
EMBMFS-S-50-50	10109117	50	M 50x1,5	14	50,50	74	77	84,50	56,9	liso	2
EMBMFS-S-50-63	10109119	50	M 63x1,5	14	50,50	74	77	84,50	56,9	liso	2

EMBMFS-C

Type	WISKA-No.	NW						VD (mm)	TL (mm)	Para mangueira de proteção	
EMBMFS-C-10-12	10109088	10	M 12x1,5	9	10	20	22	24	33,5	corrugado	5
EMBMFS-C-10-16	10109090	10	M 16x1,5	9	10	20	22	24	33,5	corrugado	5
EMBMFS-C-12-16	10109092	12	M 16x1,5	9	12	24	26	29	33,5	corrugado	5
EMBMFS-C-12-20	10109094	12	M 20x1,5	9	12	24	26	29	33,5	corrugado	5
EMBMFS-C-16-16	10109096	16	M 16x1,5	9	15,50	27	29	33	33,5	corrugado	5
EMBMFS-C-16-20	10109098	16	M 20x1,5	9	15,50	27	29	33	33,5	corrugado	5
EMBMFS-C-16-25	10109100	16	M 25x1,5	9	15,50	27	29	33	33,5	corrugado	5
EMBMFS-C-21-20	10109102	21	M 20x1,5	9	20,50	33	35	33	36,2	corrugado	5
EMBMFS-C-21-25	10109104	21	M 25x1,5	9	20,50	33	35	33	36,8	corrugado	5
EMBMFS-C-27-25	10109106	27	M 25x1,5	11	26,50	43	45	49	46,4	corrugado	5
EMBMFS-C-27-32	10109108	27	M 32x1,5	11	26,50	43	45	49	46,4	corrugado	2
EMBMFS-C-27-40	10109110	27	M 40x1,5	11	26,50	43	45	49	46,2	corrugado	2
EMBMFS-C-35-40	10109112	35	M 40x1,5	11	34,50	52	54	60	46,8	corrugado	2
EMBMFS-C-40-40	10109114	40	M 40x1,5	14	39,50	60	62	69	52,3	corrugado	2
EMBMFS-C-40-50	10109116	40	M 50x1,5	14	39,50	60	62	69	54,5	corrugado	2
EMBMFS-C-50-50	10109118	50	M 50x1,5	14	50,50	74	77	84,50	56,9	corrugado	2
EMBMFS-C-50-63	10109120	50	M 63x1,5	14	50,50	74	77	84,50	56,9	corrugado	2

Acessórios recomendados



BraceCONDUIT - Eletroduto suave, BMCG-PVC-S, aço galvanizado, Revestido de PVC, liso



BMCG-PVC-S-BK



BMCG-PVC-S-LG

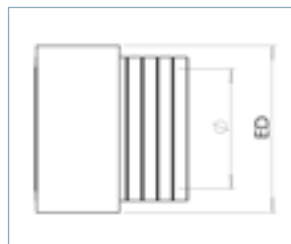

Faixa de temperatura
Material

-15 °C - 70 °C
Aço galvanizado, Tampa do tubo PVC, Superfície lisa

Type	WISKA-No.	NW	RAL-No.	ED (mm)	∅		
BMCG-PVC-S-10-BK	10109023	10	RAL 9005	15,5	10	50	30 m
BMCG-PVC-S-12-BK	10109024	12	RAL 9005	18	12	60	30 m
BMCG-PVC-S-16-BK	10109025	16	RAL 9005	21,5	15,50	70	30 m
BMCG-PVC-S-21-BK	10109026	21	RAL 9005	27	20,50	90	30 m
BMCG-PVC-S-27-BK	10109027	27	RAL 9005	33	26,50	120	30 m
BMCG-PVC-S-35-BK	10109028	35	RAL 9005	43	34,50	150	30 m
BMCG-PVC-S-40-BK	10109029	40	RAL 9005	48	39,50	200	25 m
BMCG-PVC-S-50-BK	10109030	50	RAL 9005	56	50,50	200	25 m
BMCG-PVC-S-10-LG	10109031	10	RAL 7035	15,5	10	50	30 m
BMCG-PVC-S-12-LG	10109032	12	RAL 7035	18	12	60	30 m
BMCG-PVC-S-16-LG	10109033	16	RAL 7035	21,5	15,50	70	30 m
BMCG-PVC-S-21-LG	10109034	21	RAL 7035	27	20,50	90	30 m
BMCG-PVC-S-27-LG	10109035	27	RAL 7035	33	26,50	120	30 m
BMCG-PVC-S-35-LG	10109036	35	RAL 7035	43	34,50	150	30 m
BMCG-PVC-S-40-LG	10109037	40	RAL 7035	48	39,50	200	25 m
BMCG-PVC-S-50-LG	10109038	50	RAL 7035	56	50,50	200	25 m

Acessórios recomendados



BraceCONDUIT - Eletroduto suave com maior Faixa de temperatura, BMCG-PVC-S-GT, aço galvanizado, revestido de PVC, liso



BMCG-PVC-S-BK



BMCG-PVC-S-LG

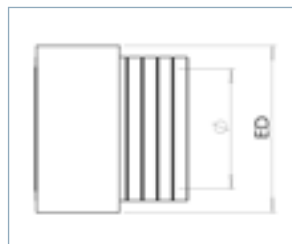

Faixa de temperatura
Material

-40 °C - 105 °C

Aço galvanizado, Tampa do tubo PVC, Superfície lisa

Type	WISKA-No.	NW	RAL-No.	ED (mm)	∅		
BMCG-PVC-S-10-BK-GT	10109039	10	RAL 9005	15,5	10	50	30 m
BMCG-PVC-S-12-BK-GT	10109040	12	RAL 9005	18	12	60	30 m
BMCG-PVC-S-16-BK-GT	10109041	16	RAL 9005	21,5	15,50	70	30 m
BMCG-PVC-S-21-BK-GT	10109042	21	RAL 9005	27	20,50	90	30 m
BMCG-PVC-S-27-BK-GT	10109043	27	RAL 9005	33	26,50	120	30 m
BMCG-PVC-S-35-BK-GT	10109044	35	RAL 9005	43	34,50	150	30 m
BMCG-PVC-S-40-BK-GT	10109045	40	RAL 9005	48	39,50	200	25 m
BMCG-PVC-S-50-BK-GT	10109046	50	RAL 9005	56	50,50	200	25 m
BMCG-PVC-S-10-LG-GT	10109047	10	RAL 7035	15,5	10	50	30 m
BMCG-PVC-S-12-LG-GT	10109048	12	RAL 7035	18	12	60	30 m
BMCG-PVC-S-16-LG-GT	10109049	16	RAL 7035	21,5	15,50	70	30 m
BMCG-PVC-S-21-LG-GT	10109050	21	RAL 7035	27	20,50	90	30 m
BMCG-PVC-S-27-LG-GT	10109051	27	RAL 7035	33	26,50	120	30 m
BMCG-PVC-S-35-LG-GT	10109052	35	RAL 7035	43	34,50	150	30 m
BMCG-PVC-S-40-LG-GT	10109053	40	RAL 7035	48	39,50	200	25 m
BMCG-PVC-S-50-LG-GT	10109054	50	RAL 7035	56	50,50	200	25 m

Acessórios recomendados



EMBMFS-S

PLÁSTICO

METAL

MARÍTIMO

EMC

EX E/I

EX D

FERROVIÁRIO

EQUILIBRAÇÃO /
VENTILAÇÃOPADRÃO
BRITÂNICO

VEDAÇÕES

MEMBRANA

CONMAXX

CONMAXX
GLANDBRACE
FITTING
PLÁSTICOBRACE
CONDUIT
PLÁSTICOBRACE
FITTING
METALBRACE
CONDUIT
METAL

BraceCONDUIT - Eletroduto com cinta de metal, BMCG-PU-C, eletroduto flexível com núcleo de aço galvanizado e exterior revestido de poliuretano livre de halogênio



BMCG-PVC-C-BK



BMCG-PVC-C-LG

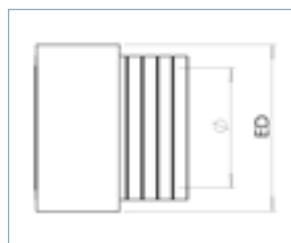

Faixa de temperatura
Material

-45 °C - 120 °C
Aço galvanizado, Tampa do tubo PU, Superfície tipo tubo ondulado

Type	WISKA-No.	NW	RAL-No.	ED (mm)	∅		
BMCG-PU-C-10-BK	10109055	10	RAL 9005	13,5	10	40	30 m
BMCG-PU-C-12-BK	10109056	12	RAL 9005	15,7	12	50	30 m
BMCG-PU-C-16-BK	10109057	16	RAL 9005	19,5	15,50	55	30 m
BMCG-PU-C-21-BK	10109058	21	RAL 9005	24,7	20,50	60	30 m
BMCG-PU-C-27-BK	10109059	27	RAL 9005	31,7	26,50	85	30 m
BMCG-PU-C-35-BK	10109060	35	RAL 9005	40	34,50	120	30 m
BMCG-PU-C-40-BK	10109061	40	RAL 9005	45	39,50	160	25 m
BMCG-PU-C-50-BK	10109062	50	RAL 9005	56	50,50	200	25 m
BMCG-PU-C-10-BL	10109063	10	azul	13,5	10	40	30 m
BMCG-PU-C-12-BL	10109064	12	azul	15,7	12	50	30 m
BMCG-PU-C-16-BL	10109065	16	azul	19,5	15,50	55	30 m
BMCG-PU-C-21-BL	10109066	21	azul	24,7	20,50	60	30 m
BMCG-PU-C-27-BL	10109067	27	azul	31,7	26,50	85	30 m
BMCG-PU-C-35-BL	10109068	35	azul	40	34,50	120	30 m
BMCG-PU-C-40-BL	10109069	40	azul	45	39,50	160	25 m
BMCG-PU-C-50-BL	10109070	50	azul	56	50,50	200	25 m
BMCG-PU-C-10-LG	10109071	10	RAL 7035	13,5	10	40	30 m
BMCG-PU-C-12-LG	10109072	12	RAL 7035	15,7	12	50	30 m
BMCG-PU-C-16-LG	10109073	16	RAL 7035	19,5	15,50	55	30 m
BMCG-PU-C-21-LG	10109074	21	RAL 7035	24,7	20,50	60	30 m
BMCG-PU-C-27-LG	10109075	27	RAL 7035	31,7	26,50	85	30 m
BMCG-PU-C-35-LG	10109076	35	RAL 7035	40	34,50	120	30 m
BMCG-PU-C-40-LG	10109077	40	RAL 7035	45	39,50	160	25 m
BMCG-PU-C-50-LG	10109078	50	RAL 7035	56	50,50	200	25 m

Acessórios recomendados



BraceCONDUIT, BMCG-PVC-BG, núcleo de aço galvanizado revestido de PVC e fio de aço trançado



BMCG-PVC-BG



BMCG-PVC-BG

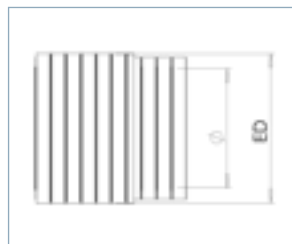

Classe de proteção
Faixa de temperatura
Material

IP67
-15 °C - 70 °C
Aço galvanizado, Tampa do tubo PVC, Superfície tipo tubo ondulado

Type	WISKA-No.	NW	ED (mm)	Ø		
BMCG-PVC-C-BG-10	10109079	10	15	10	40	30 m
BMCG-PVC-C-BG-12	10109080	12	17,5	12	50	30 m
BMCG-PVC-C-BG-16	10109081	16	21	15,50	55	30 m
BMCG-PVC-C-BG-21	10109082	21	26,5	20,50	60	30 m
BMCG-PVC-C-BG-27	10109083	27	32,5	26,50	85	30 m
BMCG-PVC-C-BG-35	10109084	35	42,5	34,50	120	30 m
BMCG-PVC-C-BG-40	10109085	40	47,5	39,50	160	25 m
BMCG-PVC-C-BG-50	10109086	50	59	50,50	200	25 m

Acessórios recomendados



EMBMFS-S

PLÁSTICO

METAL

MARÍTIMO

EMC

EX E/I

EX D

FERROVIÁRIO

EQUILIBRAÇÃO / VENTILAÇÃO

PADRÃO BRITÂNICO

VEDAÇÕES

MEMBRANA

CONMAXX

CONMAXX GLAND

BRACE FITTING PLÁSTICO

BRACE CONDUIT PLÁSTICO

BRACE FITTING METAL

BRACE CONDUIT METAL

BraceCONDUIT Clip, BMCC, aço galvanizado





BMCC



Faixa de temperatura
Material

-40 °C - 100 °C
Aço galvanizado

Type	WISKA-No.		
BMCC-13-17	10109251	8,5	10
BMCC-17-21	10109252	8,5	10
BMCC-21-26	10109253	8,5	10
BMCC-28-34	10109254	8,5	10
BMCC-37-44	10109255	10,5	10
BMCC-48-55	10109256	10,5	10

- PLÁSTICO
- METAL
- MARITIM
- EMC
- EX/EI
- EX D
- FERROVIÁRIO
- EQUALIZAÇ / VENTILAÇÃO
- PADRÃO BRITANICO
- VEDAÇÕES
- MEMBRANA
- CONNMAXX
- CONNMAXX GLAND
- BRACE FITTING PLÁSTICO
- BRACE CONDUIT PLÁSTICO
- BRACE FITTING METAL
- BRACE CONDUIT METAL

Nossa linha de produtos WISKA



Entradas de cabos

Prensa Cabos

Membranas de Borracha, passa-fios

Blocos de passagem, Sistema de entrada de cabos tipo MCT

Terminações e tubos corrugados, mangueiras para Proteção do cabos



Material para instalações elétricas

Caixas de junção e à prova de umidade para uso interno e externo

Gel para enchimento de caixas de junção

Material para ligações e conexões elétricas



Material elétrico para instalações Marítimas

Material de instalação nos materiais plástico, alumínio, latão e aço e aço inoxidável

- HNA-**Material**
- Caixas de junção, interruptores, tomadas

Caixas de junção EX, interruptores EX, tomadas EX

Soquetes para contêineres refrigerados, CEE **Material**



Iluminação

Spots e luzes LED

Luminárias multiusos

Luminárias EX

Holofote



CCTV: Vigilância por Câmera Marítima

Câmeras de rede

Câmeras Ex, à prova de explosão

Câmeras dome

Holofotes (Faróis) com Câmera combinados

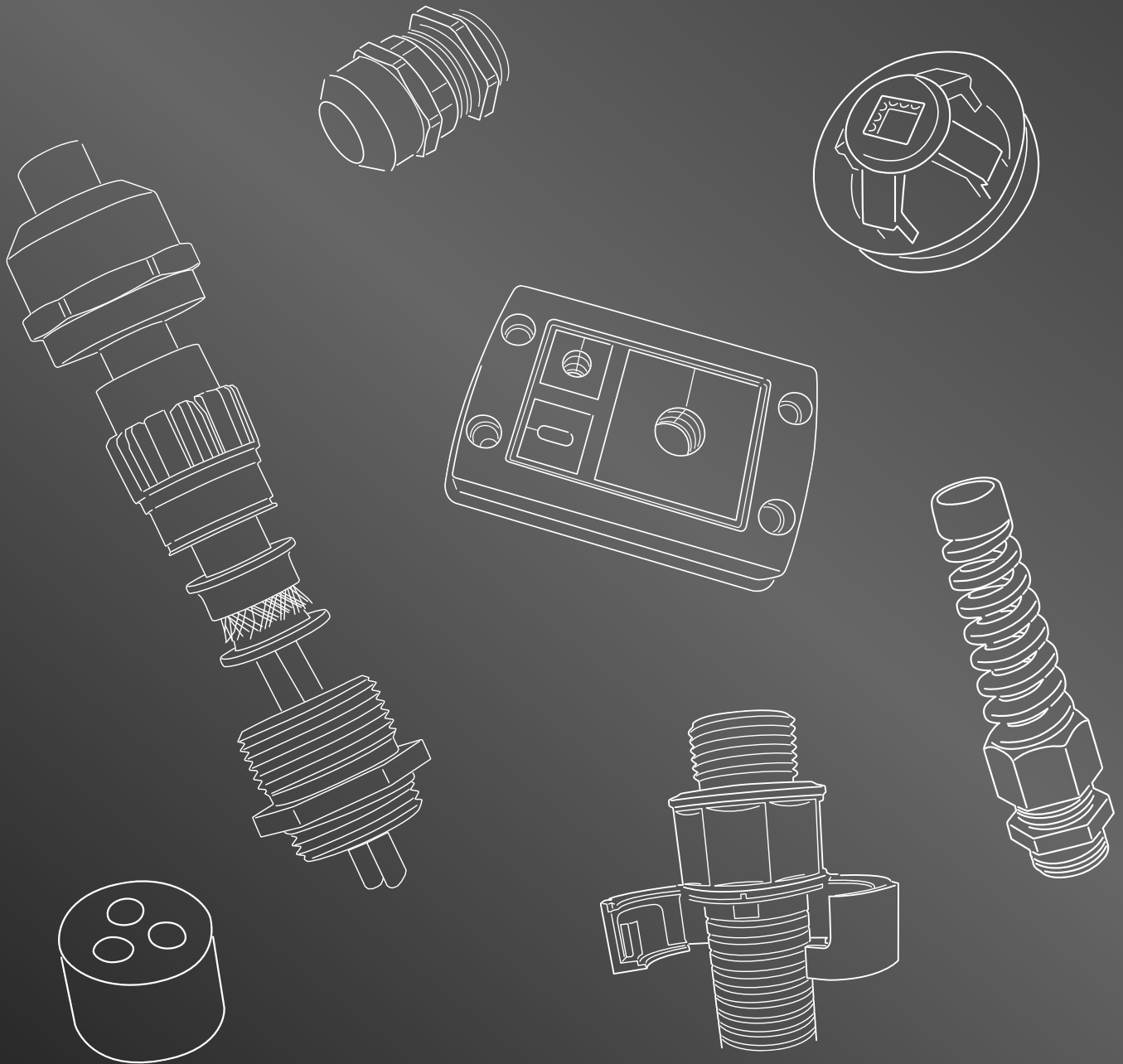

WISKA Hoppmann GmbH

Kisdorfer Weg 28
24568 Kaltenkirchen
Germany

☎ +49-4191-508-0
☎ +49-4191-508-209

contact@wiska.de
www.wiska.com

INVITÉCNICA – Material Electrotécnico, Lda.

Rua de António Alves Quelhas, 92
4475-297 MAIA
PORTUGAL

☎ +351-22-943-9770
☎ +351-22-943-9779

geral@invitecnica.pt
www.invitecnica.pt