



SCHIRTEC®

**LIGHTNING PROTECTION SYSTEMS
SURGE PROTECTION DEVICES
EARTHING MATERIALS**

2014-2015



Created For Your Safety



ICMET **BET**
BLITZSCHUTZ & EMV TECHNOLOGIEZENTRUM

TÜV
ÖSTERREICH

tgm

Staatliche Versuchsanstalt



EXTERNAL PROTECTION

SCHIRTEC E.S.E. LIGHTNING CONDUCTORS

SCHIRTEC E.S.E. Lightning Conductors protect large fields from one point by becoming active with the lightning risk by increasing the atmospheric electric field effect during thunderstorms.

The head of E.S.E. Lightning Conductors is divided into four main parts:

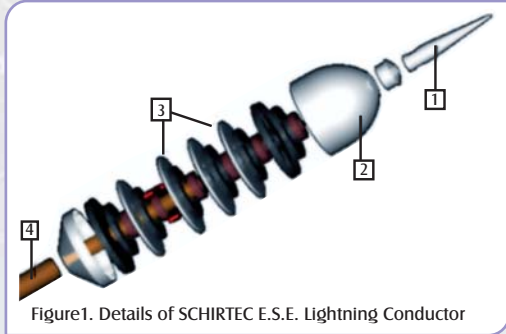

1. Air Terminal
2. Ion Generator
3. Accelerator and Atmospheric Electrodes
4. Grounding Connection Terminal

Figure1. Details of SCHIRTEC E.S.E. Lightning Conductor

The air terminal resists the biggest lightning strikes due to its high quality. The ion generator, induction coil and the protector have a high impedance. The generator is located inside of a special epoxy resin to be protected from the environmental conditions.

The accelerator and atmospheric electrodes are designed in a way that they can be charged with different potentials. The electrodes work as an additional ionization producing resource and as an accelerator.

The different protection capacities of the SCHIRTEC E.S.E. Lightning Conductors are regulated by the number of electrodes and the ion generator's impedance.

The products of SCHIRTEC are in accordance to the new NFC 17-102: 2011 and the UNE 21186: 2011 Standards. The high quality products are made of stainless steel and cause no risk for the environment, which is confirmed by TÜV Austria. The discharge capacity of lightning is confirmed by the laboratories BET Germany and CTI Vienna.

The most important factor of SCHIRTEC E.S.E. Lightning Conductors is the protection radius, which depends on the level calculation and the ΔT value, found in the product's test reports.

The level of protection is calculated according to appendix B of the NF C 17-102.

The protection radius is calculated; $R_p = (h(2D-h) + \Delta L(2D + \Delta L))^{0,5}$ $h \geq 5m$ Eq.1

h(m): True height of the Schirtec E.S.E. above the surface to be protected

D(m): Standardised striking distance $D = 20m$ (level I), $30m$ (level II), $45m$ (level III) or $60m$ (level IV)

ΔL (m): Triggering advance ΔT measured during efficiency tests acc. to appendix C of the NF C 17-102 standard which allows ΔT to be calculated using the formula $\Delta L = V \cdot \Delta T$, $V = 10^6$ m/s from NF C 17-102.

A sample calculation for SCHIRTEC-A:

If you calculate **Level-I** according to appendix B of the NF C 17-102
For $D=20$ m, $\Delta L=60$ m, $h=6$ m,
from $R_p = (h(2D-h) + \Delta L(2D + \Delta L))^{0,5}$...Eq.1
Protection radius is $R_p = 79$ m calculated.

If you calculate **Level-II** according to appendix B of the NF C 17-102
For $D=30$ m, $\Delta L=60$ m, $h=6$ m,
from Eq.1, $R_p=87$ m calculated.

If you calculate **Level-III** according to appendix B of the NF C 17-102
For $D=45$ m, $\Delta L=60$ m, $h=6$ m,
from Eq.1, $R_p=97$ m calculated.

If you calculate **Level-IV** according to appendix B of the NF C 17-102
For $D=60$ m, $\Delta L=60$ m, $h=6$ m
from Eq.1, $R_p=107$ m calculated

The Protection Radius For SCHIRTEC E.S.E. Lightning Conductors (According to NF C 17-102)

Rp (m) h(m) \ Np	SCHIRTEC-AM ($\Delta T: 15 \mu s$)				SCHIRTEC-AS ($\Delta T: 30 \mu s$)				SCHIRTEC-DAS ($\Delta T: 45 \mu s$)				SCHIRTEC-A/DA ($\Delta T: 60 \mu s$)			
	I	II	III	IV	I	II	III	IV	I	II	III	IV	I	II	III	IV
2	13	15	18	20	19	22	25	28	25	28	32	36	31	35	39	43
4	25	27	36	41	38	44	51	57	51	57	64	72	63	69	78	85
5	32	37	45	51	48	55	63	71	63	71	81	89	79	86	97	107
6	32	38	46	52	48	55	64	72	63	71	81	90	79	87	97	107
8	33	39	47	54	49	56	65	73	64	72	82	91	79	87	98	108
10	34	41	49	56	49	57	66	75	64	72	83	92	79	88	99	109
20	35	43	55	63	50	59	71	81	65	74	86	97	80	89	102	113
30	35	45	58	69	50	60	73	85	65	75	89	101	80	90	104	116



SCHIRTEC®

E.S.E. SCHIRTEC LIGHTNING CONDUCTORS

					
Model	S-AM	S-AS	S-A	S-DAS*	S-DA*
Protection Radius	15 μ s	30 μ s	60 μ s	45 μ s	63 μ s
Tested Protection Radius ΔT (μ s)	17 μ s	32 μ s	65 μ s	47 μ s	73 μ s
Size (cm)	48x9	55x12	59x12	66x12	70x12
Weight (kg)	1,2	2,6	2,8	3,8	4,1
Material	Stainless steel				
Standards	NFC 17-102: 2011 and UNE 21186: 2011				

* PREMIUM Models with second ion generator for additional safety

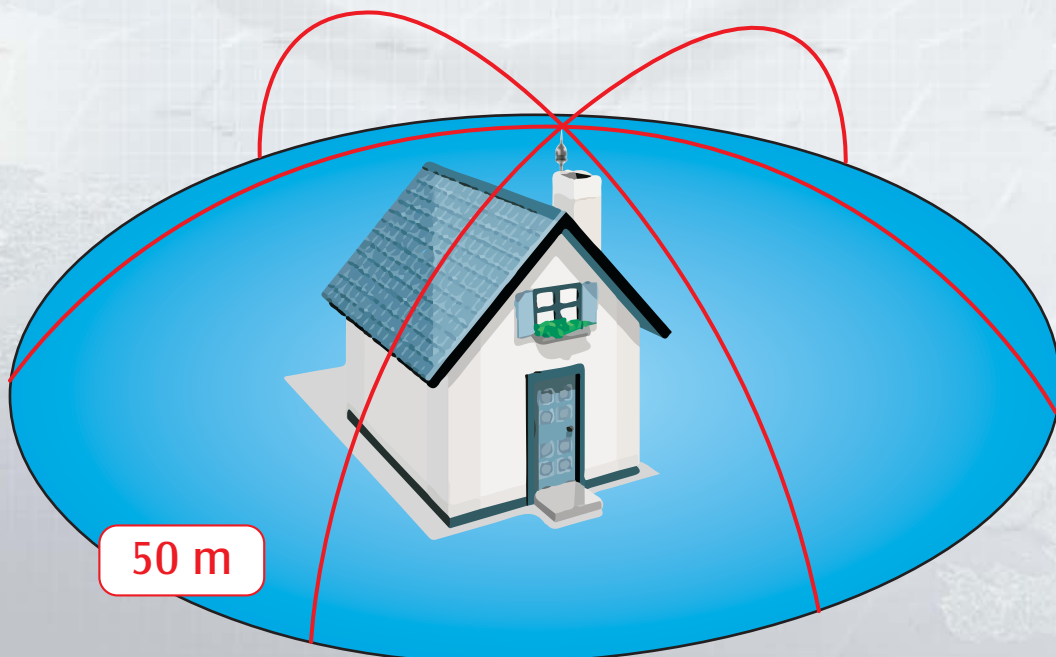



SCHIRTEC®

SCHIRTEC E.S.E. LIGHTNING CONDUCTORS TESTED NFC 17-102 2011 VERSION

RESEARCH DEVELOPMENT AND TESTING
NATIONAL INSTITUTE FOR ELECTRICAL
ENGINEERING
ICMET CRAIOVA
DEPARTMENT LABORATORIES
High Voltage Laboratory and Experimental Compatibility
BVI, ENP

Str. Suceava No. 104, 20074 Craiova, Romania
Phone: +40 251 40202, 40486 Fax: +40 251 40485
www.schirtec.ro, www.icmet.ro

TEST REPORT
No. 43937 / 26.09.2013

TESTED BY SCHIRTEC AD
Sponsor: S.A.S. Suceava SA, A-1259 Vitea, Suceava

MANUFACTURER SCHIRTEC AD
Sponsor: S.A.S. Suceava SA, A-1259 Vitea, Suceava

3. TESTED PRODUCT: Early Resonant Evanescent (E.R.E.) Lightning Conductor type
SCHIRTEC - A (S-A-N)

4. REFERENCE STANDARDS: NFC 17-102 (2011), Annex C
EN6 20106 (2011), Annex C

5. TEST PERFORMANCE: Determination of the E.S.E. lightning conductor efficiency

6. TEST DATE: 10.03.2013

7. TEST RESULTS: These are presented in the measurements results.

8. The report contains 13 pages.

9. The test report is valid in English, may not be relevant in laboratory and report 5.3 and 6 are valid in the Romanian language.

HEAD OF BY DIVISION: Eng. PETRU POP
HEAD OF BY LABORATORY: Eng. ROȘA LILIA

10. Report of the test results is available on the website www.schirtec.ro under the code: 43937 / 26.09.2013
11. All rights reserved. No part of this publication may be reproduced, stored in a retrieval system, or transmitted, in any form or by any means, electronic, mechanical, photocopying, recording, or by any information storage and retrieval system, without the prior written permission of the publisher.

Code: 43937

TEST REPORT No. 43937 page 7

A Test on E.S.E. Lightning Conductor type: SCHIRTEC-A (S-A-N)

9.1. Receipt date: 12.07.2013
9.2. Test date: 10.03.2013

9.3. Atmospheric conditions

BEFORE TEST	$p = 1013 \text{ hPa}$	$T = 20.1 \text{ }^\circ\text{C}$
	$h = 116 \text{ m}$	$W = 0.1 \text{ mm/h}$
MIDDLE OF THE TEST	$p = 1013 \text{ hPa}$	$T = 20.1 \text{ }^\circ\text{C}$
	$h = 116 \text{ m}$	$W = 0.1 \text{ mm/h}$
END OF THE TEST	$p = 1013 \text{ hPa}$	$T = 20.1 \text{ }^\circ\text{C}$
	$h = 116 \text{ m}$	$W = 0.1 \text{ mm/h}$

9.4. Results: See table from page 9

Number of significant impulses: 10

Average of significant T_d : Break down times calculated from the experimental results is $T_{d50} = 170.6 \text{ }^\circ\text{s}$ with a standard deviation $T_{d50} = 19.6 \text{ }^\circ\text{s}$.

By multiplying T_{d50} on the reference waveform it was obtained $T_{50} = 278.11 \text{ }^\circ\text{s}$.

See curves from page 10

Allowing uncertainty for $\pm 2 \text{ }^\circ\text{ }^\circ\text{s}$.

The measured value of statistical moment obtained by multiplying the standard uncertainty to the average value of T_d . The value of measured for within the assigned range of values with probability of 95%.

Early return voltage: $U_T = T_{50} \cdot I_{50} = 100.22 \cdot 170.6 = 17062 \text{ }^\circ\text{s} \cdot \text{A}$ at 1.10 kA .

The tested lightning conductors in E.S.E. type, compliance criteria are summarized in table below.

Reference conditions according to NFC 17-102 (2011), Annex C, clause C.3.3.3:

- Test: $T_{50} = 170.6 \text{ }^\circ\text{s}$
- Mean: $T_{50} = 170.6 \text{ }^\circ\text{s}$
- Max: $T_{50} = 170.6 \text{ }^\circ\text{s}$
- Min: $T_{50} = 170.6 \text{ }^\circ\text{s}$

Test: $T_{50} = 170.6 \text{ }^\circ\text{s}$

Code: 43937

RESEARCH DEVELOPMENT AND TESTING
NATIONAL INSTITUTE FOR ELECTRICAL
ENGINEERING
ICMET CRAIOVA
DEPARTMENT LABORATORIES
High Voltage Laboratory and Experimental Compatibility
BVI, ENP

Str. Suceava No. 104, 20074 Craiova, Romania
Phone: +40 251 40202, 40486 Fax: +40 251 40485
www.schirtec.ro, www.icmet.ro

TEST REPORT
No. 43952 / 26.09.2013

TESTED BY SCHIRTEC AD
Sponsor: S.A.S. Suceava SA, A-1259 Vitea, Suceava

MANUFACTURER SCHIRTEC AD
Sponsor: S.A.S. Suceava SA, A-1259 Vitea, Suceava

3. TESTED PRODUCT: Early Resonant Evanescent (E.R.E.) Lightning Conductor type
SCHIRTEC - B (S-B-N)

4. REFERENCE STANDARDS: NFC 17-102 (2011), Annex C
EN6 20106 (2011), Annex C

5. TEST PERFORMANCE: Determination of the E.S.E. lightning conductor efficiency

6. TEST DATE: 10.03.2013

7. TEST RESULTS: These are presented in the measurements results.

8. The report contains 13 pages.

9. The test report is valid in English, may not be relevant in laboratory and report 5.3 and 6 are valid in the Romanian language.

HEAD OF BY DIVISION: Eng. PETRU POP
HEAD OF BY LABORATORY: Eng. ROȘA LILIA

10. Report of the test results is available on the website www.schirtec.ro under the code: 43952 / 26.09.2013
11. All rights reserved. No part of this publication may be reproduced, stored in a retrieval system, or transmitted, in any form or by any means, electronic, mechanical, photocopying, recording, or by any information storage and retrieval system, without the prior written permission of the publisher.

Code: 43952

TEST REPORT No. 43952 page 7

A Test on E.S.E. Lightning Conductor type: SCHIRTEC-B (S-B-N)

9.1. Receipt date: 12.07.2013
9.2. Test date: 10.03.2013

9.3. Atmospheric conditions

BEFORE TEST	$p = 1013 \text{ hPa}$	$T = 20.1 \text{ }^\circ\text{C}$
	$h = 116 \text{ m}$	$W = 0.1 \text{ mm/h}$
MIDDLE OF THE TEST	$p = 1013 \text{ hPa}$	$T = 20.1 \text{ }^\circ\text{C}$
	$h = 116 \text{ m}$	$W = 0.1 \text{ mm/h}$
END OF THE TEST	$p = 1013 \text{ hPa}$	$T = 20.1 \text{ }^\circ\text{C}$
	$h = 116 \text{ m}$	$W = 0.1 \text{ mm/h}$

9.4. Results: See table from page 9

Number of significant impulses: 10

Average of significant T_d : Break down times calculated from the experimental results is $T_{d50} = 170.6 \text{ }^\circ\text{s}$ with a standard deviation $T_{d50} = 19.6 \text{ }^\circ\text{s}$.

By multiplying T_{d50} on the reference waveform it was obtained $T_{50} = 278.11 \text{ }^\circ\text{s}$.

See curves from page 10

Allowing uncertainty for $\pm 2 \text{ }^\circ\text{ }^\circ\text{s}$.

The measured value of statistical moment obtained by multiplying the standard uncertainty to the average value of T_d . The value of measured for within the assigned range of values with probability of 95%.

Early return voltage: $U_T = T_{50} \cdot I_{50} = 100.22 \cdot 170.6 = 17062 \text{ }^\circ\text{s} \cdot \text{A}$ at 1.10 kA .

The tested lightning conductors in E.S.E. type, compliance criteria are summarized in table below.

Reference conditions according to NFC 17-102 (2011), Annex C, clause C.3.3.3:

- Test: $T_{50} = 170.6 \text{ }^\circ\text{s}$
- Mean: $T_{50} = 170.6 \text{ }^\circ\text{s}$
- Max: $T_{50} = 170.6 \text{ }^\circ\text{s}$
- Min: $T_{50} = 170.6 \text{ }^\circ\text{s}$

Test: $T_{50} = 170.6 \text{ }^\circ\text{s}$

Code: 43952

RESEARCH DEVELOPMENT AND TESTING
NATIONAL INSTITUTE FOR ELECTRICAL
ENGINEERING
ICMET CRAIOVA
DEPARTMENT LABORATORIES
High Voltage Laboratory and Experimental Compatibility
BVI, ENP

Str. Suceava No. 104, 20074 Craiova, Romania
Phone: +40 251 40202, 40486 Fax: +40 251 40485
www.schirtec.ro, www.icmet.ro

TEST REPORT
No. 43637 / 10.01.2013

TESTED BY SCHIRTEC AD
Sponsor: S.A.S. Suceava SA, A-1259 Vitea, Suceava

MANUFACTURER SCHIRTEC AD
Sponsor: S.A.S. Suceava SA, A-1259 Vitea, Suceava

3. TESTED PRODUCT: Early Resonant Evanescent (E.R.E.) Lightning Conductor type
SCHIRTEC - A (S-A-N)

4. REFERENCE STANDARDS: NFC 17-102 (2011), Annex C
EN6 20106 (2011), Annex C

5. TEST PERFORMANCE: Determination of the relative efficiency of the E.S.E. lightning conductor

6. TEST DATE: 10.01.2013

7. TEST RESULTS: These are presented in the measurements results.

8. The report contains 13 pages.

9. The test report is valid in English, may not be relevant in laboratory and report 5.3 and 6 are valid in the Romanian language.

HEAD OF BY DIVISION: Eng. PETRU POP
HEAD OF BY LABORATORY: Eng. ROȘA LILIA

10. Report of the test results is available on the website www.schirtec.ro under the code: 43637 / 10.01.2013
11. All rights reserved. No part of this publication may be reproduced, stored in a retrieval system, or transmitted, in any form or by any means, electronic, mechanical, photocopying, recording, or by any information storage and retrieval system, without the prior written permission of the publisher.

Code: 43637

TEST REPORT No. 43637 page 7

A Test on E.S.E. type SCHIRTEC - A

9.1. Receipt date: 07.01.2013
9.2. Test date: 10.01.2013

9.3. Atmospheric conditions

BEFORE TEST	$p = 1013 \text{ hPa}$	$T = 19.8 \text{ }^\circ\text{C}$
	$h = 116 \text{ m}$	$W = 0.1 \text{ mm/h}$
AFTER TEST	$p = 1013 \text{ hPa}$	$T = 19.8 \text{ }^\circ\text{C}$
	$h = 116 \text{ m}$	$W = 0.1 \text{ mm/h}$

9.4. Results: See table from page 9

Number of significant impulses: 100

Average of significant T_d :

- calculated from the experimental tests $T_{d50} = 207 \text{ }^\circ\text{s}$
- calculated on the reference waveform: $T_{d50} = 278.2 \text{ }^\circ\text{s}$

See curves from page 10

Allowing uncertainty for $\pm 2 \text{ }^\circ\text{ }^\circ\text{s}$.

The measured value of statistical moment obtained by multiplying the standard uncertainty to the average value of T_d . The value of measured for within the assigned range of values with probability of 95%.

Shooting advance: $U_T = T_{50} \cdot I_{50} = 100.22 \cdot 170.6 = 17062 \text{ }^\circ\text{s} \cdot \text{A}$ at 1.10 kA .

Code: 43637

RESEARCH DEVELOPMENT AND TESTING
NATIONAL INSTITUTE FOR ELECTRICAL
ENGINEERING
ICMET CRAIOVA
DEPARTMENT LABORATORIES
High Voltage Laboratory and Experimental Compatibility
BVI, ENP

Str. Suceava No. 104, 20074 Craiova, Romania
Phone: +40 251 40202, 40486 Fax: +40 251 40485
www.schirtec.ro, www.icmet.ro

TEST REPORT
No. 43955 / 26.09.2013

TESTED BY SCHIRTEC AD
Sponsor: S.A.S. Suceava SA, A-1259 Vitea, Suceava

MANUFACTURER SCHIRTEC AD
Sponsor: S.A.S. Suceava SA, A-1259 Vitea, Suceava

3. TESTED PRODUCT: Early Resonant Evanescent (E.R.E.) Lightning Conductor type
SCHIRTEC - B (S-B-N)

4. REFERENCE STANDARDS: NFC 17-102 (2011), Annex C
EN6 20106 (2011), Annex C

5. TEST PERFORMANCE: Determination of the E.S.E. lightning conductor efficiency

6. TEST DATE: 10.03.2013

7. TEST RESULTS: These are presented in the measurements results.

8. The report contains 13 pages.

9. The test report is valid in English, may not be relevant in laboratory and report 5.3 and 6 are valid in the Romanian language.

HEAD OF BY DIVISION: Eng. PETRU POP
HEAD OF BY LABORATORY: Eng. ROȘA LILIA

10. Report of the test results is available on the website www.schirtec.ro under the code: 43955 / 26.09.2013
11. All rights reserved. No part of this publication may be reproduced, stored in a retrieval system, or transmitted, in any form or by any means, electronic, mechanical, photocopying, recording, or by any information storage and retrieval system, without the prior written permission of the publisher.

Code: 43955

TEST REPORT No. 43955 page 7

A Test on E.S.E. Lightning Conductor type: SCHIRTEC-B (S-B-N)

9.1. Receipt date: 12.07.2013
9.2. Test date: 10.03.2013

9.3. Atmospheric conditions

BEFORE TEST	$p = 1013 \text{ hPa}$	$T = 20.1 \text{ }^\circ\text{C}$
	$h = 116 \text{ m}$	$W = 0.1 \text{ mm/h}$
MIDDLE OF THE TEST	$p = 1013 \text{ hPa}$	$T = 20.1 \text{ }^\circ\text{C}$
	$h = 116 \text{ m}$	$W = 0.1 \text{ mm/h}$
END OF THE TEST	$p = 1013 \text{ hPa}$	$T = 20.1 \text{ }^\circ\text{C}$
	$h = 116 \text{ m}$	$W = 0.1 \text{ mm/h}$

9.4. Results: See table from page 9

Number of significant impulses: 10

Average of significant T_d : Break down times calculated from the experimental results is $T_{d50} = 170.6 \text{ }^\circ\text{s}$ with a standard deviation $T_{d50} = 19.6 \text{ }^\circ\text{s}$.

By multiplying T_{d50} on the reference waveform it was obtained $T_{50} = 278.11 \text{ }^\circ\text{s}$.

See curves from page 10

Allowing uncertainty for $\pm 2 \text{ }^\circ\text{ }^\circ\text{s}$.

The measured value of statistical moment obtained by multiplying the standard uncertainty to the average value of T_d . The value of measured for within the assigned range of values with probability of 95%.

Early return voltage: $U_T = T_{50} \cdot I_{50} = 100.22 \cdot 170.6 = 17062 \text{ }^\circ\text{s} \cdot \text{A}$ at 1.10 kA .

The tested lightning conductors in E.S.E. type, compliance criteria are summarized in table below.

Reference conditions according to NFC 17-102 (2011), Annex C, clause C.3.3.3:

- Test: $T_{50} = 170.6 \text{ }^\circ\text{s}$
- Mean: $T_{50} = 170.6 \text{ }^\circ\text{s}$
- Max: $T_{50} = 170.6 \text{ }^\circ\text{s}$
- Min: $T_{50} = 170.6 \text{ }^\circ\text{s}$

Test: $T_{50} = 170.6 \text{ }^\circ\text{s}$

Code: 43955

RESEARCH DEVELOPMENT AND TESTING
NATIONAL INSTITUTE FOR ELECTRICAL
ENGINEERING
ICMET CRAIOVA
DEPARTMENT LABORATORIES
High Voltage Laboratory and Experimental Compatibility
BVI, ENP

Str. Suceava No. 104, 20074 Craiova, Romania
Phone: +40 251 40202, 40486 Fax: +40 251 40485
www.schirtec.ro, www.icmet.ro

TEST REPORT
No. 43634 / 09.01.2013

TESTED BY SCHIRTEC AD
Sponsor: S.A.S. Suceava SA, A-1259 Vitea, Suceava

MANUFACTURER SCHIRTEC AD
Sponsor: S.A.S. Suceava SA, A-1259 Vitea, Suceava

3. TESTED PRODUCT: Early Resonant Evanescent (E.R.E.) Lightning Conductor type
SCHIRTEC - BA (S - BA)

4. REFERENCE STANDARDS: NFC 17-102 (2011), Annex C
EN6 20106 (2011), Annex C

5. TEST PERFORMANCE: Determination of the relative efficiency of the E.S.E. lightning conductor

6. TEST DATE: 09.01.2013

7. TEST RESULTS: These are presented in the measurements results.

8. The report contains 13 pages.

9. The test report is valid in English, may not be relevant in laboratory and report 5.3 and 6 are valid in the Romanian language.

HEAD OF BY DIVISION: Eng. PETRU POP
HEAD OF BY LABORATORY: Eng. ROȘA LILIA

10. Report of the test results is available on the website www.schirtec.ro under the code: 43634 / 09.01.2013
11. All rights reserved. No part of this publication may be reproduced, stored in a retrieval system, or transmitted, in any form or by any means, electronic, mechanical, photocopying, recording, or by any information storage and retrieval system, without the prior written permission of the publisher.

Code: 43634

TEST REPORT No. 43634 page 7

A Test on E.S.E. type SCHIRTEC - BA

9.1. Receipt date: 07.01.2013
9.2. Test date: 09.01.2013

9.3. Atmospheric conditions

BEFORE TEST	$p = 1013 \text{ hPa}$	$T = 19.8 \text{ }^\circ\text{C}$
	$h = 116 \text{ m}$	$W = 0.1 \text{ mm/h}$
AFTER TEST	$p = 1013 \text{ hPa}$	$T = 19.8 \text{ }^\circ\text{C}$
	$h = 116 \text{ m}$	$W = 0.1 \text{ mm/h}$

9.4. Results: See table from page 9

Number of significant impulses: 100

Average of significant T_d :

- calculated from the experimental tests $T_{d50} = 207 \text{ }^\circ\text{s}$
- calculated on the reference waveform: $T_{d50} = 278.2 \text{ }^\circ\text{s}$

See curves from page 10

Allowing uncertainty for $\pm 2 \text{ }^\circ\text{ }^\circ\text{s}$.

The measured value of statistical moment obtained by multiplying the standard uncertainty to the average value of T_d . The value of measured for within the assigned range of values with probability of 95%.

Shooting advance: $U_T = T_{50} \cdot I_{50} = 100.22 \cdot 170.6 = 17062 \text{ }^\circ\text{s} \cdot \text{A}$ at 1.10 kA .

Code: 43634



SCHIRTEC®

SCHIRTEC CERTIFICATES & TEST REPORTS

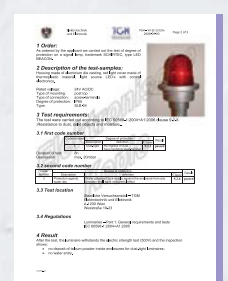
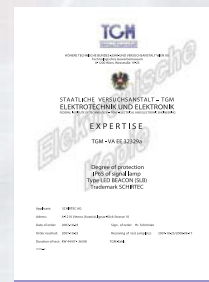
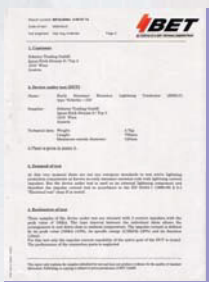
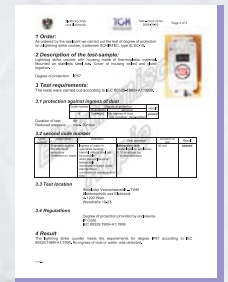
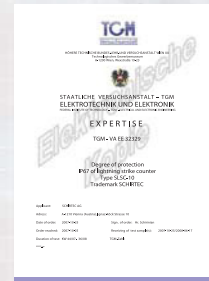
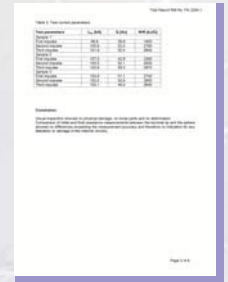



SCHIRTEC®

SOLAR TESTER SRC-1T

All SCHIRTEC E.S.E. Lightning Conductors can be tested any time by utilizing the respective tester. The Tester indicates OK (green LED) or FAULT (red LED). There are two different types of testers available.

	Name	Description	Dimension (cm)
	SA-1T	Tester for E.S.E.	6x9,5x3x8

1. SRC-1T

The solar tester works remotely. The testing device stores energy to operate for 24 hours by an exposition of 5-7 hours of sun light daily.

2. Installation Manual

1. The Testing Device is installed at a 45 degree angle to the pole facing south.
2. The Testing Device is connected through a cable with the E.S.E. Lightning Conductor.
3. The Testing Device has to be switched ON.
4. A test has to be performed
(See Chapter 3. How to perform a test?)

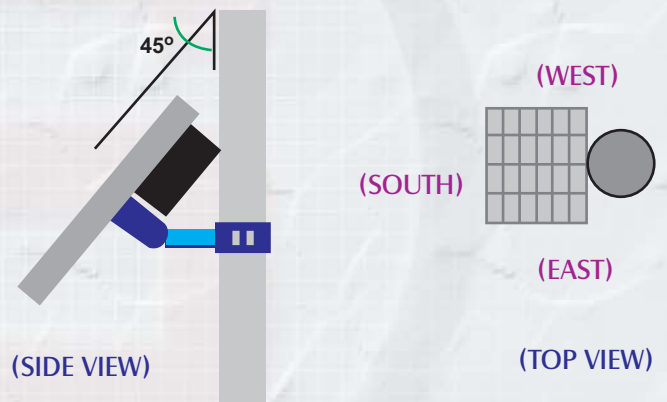

In order to perform a test of the functionality of any SCHIRTEC E.S.E. Lightning Conductor you have to:

- 1) Press the red TEST button for 2 - 3 seconds on the Remote Controller.
- 2) The RX/TX LED lights up in red.
- 3) After releasing the button the Testing Device, which is connected to the SCHIRTEC E.S.E. Lightning Conductor, performs the test.
- 4) After a few seconds the test result will be transmitted via radio frequency to the



Remote Controller:

When the green OK LED lights up and starts blinking; the E.S.E. Lightning Conductor is fully functional.

When the red FAULT LED lights up and starts blinking; the E.S.E. Lightning Conductor is not functional and has to be controlled immediately.

Please note that the Testing Device stores energy to operate for 24 hours taking into consideration that it is exposed to 5-7 hours of sun light daily.



SCHIRTEC®

Exothermic Welding SCHIRTEC



Exothermic welding is a process to join materials permanently with the conductors. Exothermic welding is usually used for welding copper conductors but it is suitable for a wide range of metals.

Product Packaging

SCHIRTEC Exothermic Welding Powder is available in cartridges with the following content:

- 65 g
- 90 g
- 115 g
- 150 g
- 200 g
- 250 g



The lack of an external heat source and the benefit of joining materials permanently within seconds are one of the advantages of Exothermic Welding. The Exothermic Welding has an excellent corrosion resistance and does not suffer from increased electrical resistance over the lifetime of the installation.

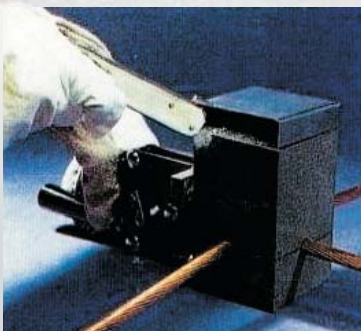



SCHIRTEC®

SA-1T (SCHIRTEC LIGHTNING CONDUCTOR TESTER)



The SCHIRTEC Lightning Conductors can be checked by this Tester every time. The Tester will indicate OK or FAULT with the help of red or green LED.

Ref.No:	Description	Dimension (cm)
SA-1T	SCHIRTEC Tester	6x9,5x3,8

SLSC-10 (SCHIRTEC LIGHTNING STRIKE COUNTER)



Ref.No:	Description
SLSC-10	SCHIRTEC Lightning Strike Counter

Description

The Lightning Strikes will be detected and recorded by the SLSC-10. This device can also show the intact operation of the Lightning System.

Why Should We Use a Lightning Counter?

By using an inductive record, the counter is able accurately to count all lightning events for a later reference.

Operating Principle

SLSC-10 works with an inductive effect of the lightning strike current. The events are monitored by a mechanical counter display. The counter includes a high frequency transformer.

Applications and Descriptions

- ⊗ Currents detected from 2 to 100 kA
- ⊗ Nonresetable
- ⊗ Mechanical Counter with 6 digits
- ⊗ Easy mountable
- ⊗ Testable with 9V Battery
- ⊗ Does not require any external power supply
- ⊗ Produced according to IP 67 (certified by TGM Laboratory)
- ⊗ Serial Counter
- ⊗ Dimensions: 11,3x7x4,8 cm

VARIOUS LIGHTNING PROTECTION ACCESSORIES & EARTHING MATERIALS





SLB (SCHIRTEC LED BEACON)



Properties,

- Ⓢ Special designed red glass cover.
- Ⓢ Aluminium frame.
- Ⓢ Anti-static protection covered circuit.
- Ⓢ Produced according to IP 65 (certified by TGM Laboratory)

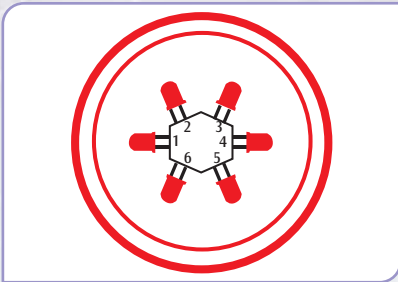

The SCHIRTEC LED BEACON is covered by a red coloured glass and especially manufactured to show a maximum light distribution.

The SCHIRTEC LED BEACON's frame is manufactured by an injection aluminium technology. Upon it, a special kit is mounted in order to facilitate the montage.

For the security purpose, the red glass cover is connected with a slim steel wire (minimum 30 cm) to the aluminium frame firmly.

There is a microprocessor in the electronic circuit of this device which enables us to program the flashing periods.

As remarked in the above figure, there are 6 sets of LED placed in the device hexagonally. Each set consists of 8 pieces of LED totalled to 48 (6X8) pieces of LED. With the help of them, an efficient light distribution is possible for 360 degrees.

The inside micro controller checks all the LEDs permanently and tries to find out any failure. If any failure is located, the error LED should be lighted and the failure contact outputs will be activated.

Characteristic of LED ;

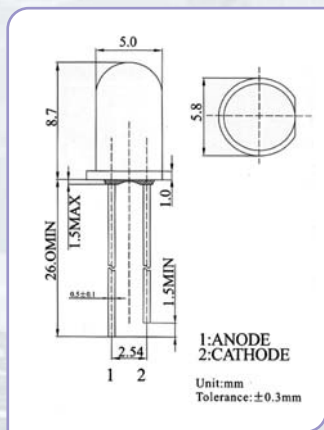

Directive Characteristics (Ta=25°C)

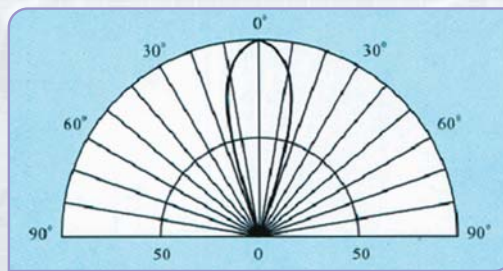

Relative Luminous Intensity (The view of 30 degrees)

This data shows some typical values.

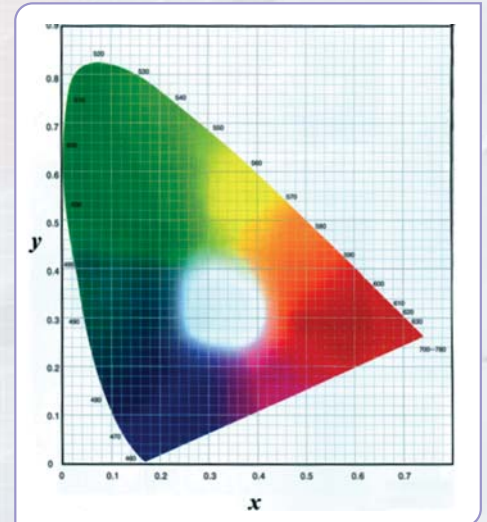

SCHIRTEC LED BEACON			
	SLB-24	SLB-48	SLB-220
Power Supply	24 V AC/ V DC	36-72 V AC/ V DC	220 V AC
Power Consumption		max. 3 W	
Luminescence (typical)		32 cd	
Luminescence (maximum)		46 cd	
Height & Diameter		206&135 mm	
Operating Temperature (°C)		- 40 to +85°C	
Weight		1,5 kg	



SCHIRTEC®

E.S.E. LIGHTNING CONDUCTORS & PRODUCTS

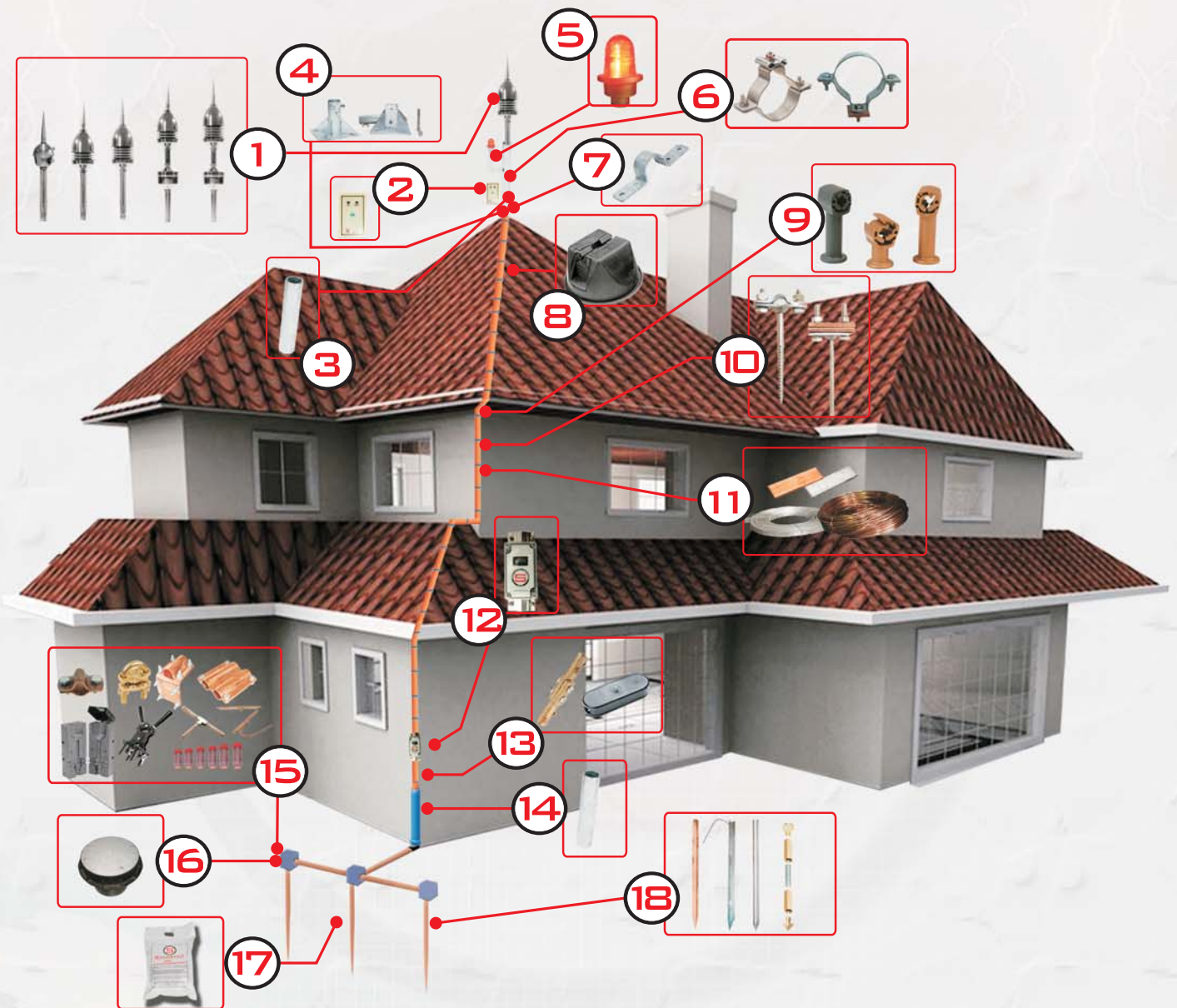

- | | |
|--|--|
| ① E.S.E. Lightning Conductors | ⑩ Wall Holders |
| ② E.S.E. Lightning Conductors Tester | ⑪ Down Conductors |
| ③ Galvanized Mast | ⑫ Lightning Strike Counter |
| ④ Mast Base | ⑬ Test Clamps |
| ⑤ SCHIRTEC LED Beacon | ⑭ Protection Pipe |
| ⑥ Mast Clamp | ⑮ Earthing Rod Clamps and Exothermic Welding |
| ⑦ Mast Clip | ⑯ Plastic, Concrete Inspection Pits |
| ⑧ Plastic Holders for Isolated Floor/Roofs | ⑰ SCHIRTEC Earthing Enhancement Material |
| ⑨ Plastic Holders for Isolated Walls | ⑱ Earthing Rods |



SCHIRTEC®

INTERNAL PROTECTION SURGE PROTECTION DEVICES

POWER SUPPLY SYSTEMS LIGHTNING ARRESTER CLASS I



- S45 = Encapsulated power spark gap $I_{imp} = 60\text{kA (L/N)}$, $U_N = 230\text{V/50Hz}$, $I_{max} = 100\text{ kA}$, $U_p \leq 2,5\text{ kV}$
- S50-50 = Encapsulated power spark gap $I_{imp} = 50\text{kA(L/N)}$, $U_N = 230\text{V/50Hz}$, $I_{max} = 110\text{ kA}$, $U_p \leq 1,3\text{ kV}$
- S55 = Encapsulated power spark gap $I_{imp} = 60\text{kA (L/N)}$, $U_N = 230\text{V/50Hz}$, $I_{max} = 100\text{ kA}$, $U_p \leq 4\text{ kV}$
- S50-3 = Encapsulated power spark gap $I_{imp} = 50\text{kA (L/N)}$, $U_N = 230\text{V/50Hz}$, $I_{max} = 110\text{ kA}$, $U_p \leq 1,3\text{ kV}$
- S100 = Encapsulated power spark gap $I_{imp} = 120\text{kA (N/PE)}$, $U_c = 255\text{V/50Hz}$, $I_{max} = 160\text{kA}$, $U_p \leq 2\text{ kV}$
- SB 120 = Lightning arrester class I. 85kA (8/20) , $U_N = 120\text{V}$, $I_{max} = 100\text{ kA}$, $U_p \leq 950\text{V}$
- SB 230 = Lightning arrester class I. 85kA (8/20) , $U_N = 230\text{V}$, $I_{max} = 100\text{ kA}$, $U_p \leq 1000\text{V}$
- SB 400 = Lightning arrester class I. 85kA (8/20) , $U_N = 400\text{V}$, $I_{max} = 100\text{ kA}$, $U_p \leq 1600\text{ V}$
- SB 500 = Lightning arrester class I. 85kA (8/20) , $U_N = 500\text{V}$, $I_{max} = 100\text{ kA}$, $U_p \leq 2100\text{ V}$
- SB 120S = Lightning arrester class I. $85\text{kA (8/20) + dist.sig.}$, $U_N = 120\text{V}$, $I_{max} = 100\text{ kA}$, $U_p \leq 950\text{V}$
- SB 230S = Lightning arrester class I. $85\text{kA (8/20) + dist.sig.}$, $U_N = 230\text{V}$, $I_{max} = 100\text{ kA}$, $U_p \leq 1000\text{V}$
- SB 400S = Lightning arrester class I. $85\text{kA (8/20) + dist.sig.}$, $U_N = 400\text{V}$, $I_{max} = 100\text{ kA}$, $U_p \leq 1600\text{ V}$
- SB 500S = Lightning arrester class I. $85\text{kA (8/20) + dist.sig.}$, $U_N = 500\text{V}$, $I_{max} = 100\text{ kA}$, $U_p \leq 2100\text{ V}$
- SBT 120 = Lightning arrester class I. 80kA (8/20) , $U_N = 120\text{ V}$, $I_{max} = 80\text{kA}$, $U_p \leq 1\text{kV}$
- SBT 230 = Lightning arrester class I. 80kA (8/20) , $U_N = 230\text{ V}$, $I_{max} = 80\text{ kA}$, $U_p \leq 2\text{kV}$
- SBT 400 = Lightning arrester class I. 80kA (8/20) , $U_N = 400\text{ V}$, $I_{max} = 80\text{kA}$, $U_p \leq 2\text{kV}$
- SBT 120S = Lightning arrester class I. $80\text{kA (8/20) + dist.sig.}$, $U_N = 120\text{V}$, $I_{max} = 80\text{kA}$, $U_p \leq 1\text{kV}$
- SBT 230S = Lightning arrester class I. $80\text{kA (8/20) + dist.sig.}$, $U_N = 230\text{V}$, $I_{max} = 80\text{ kA}$, $U_p \leq 2\text{kV}$
- SBT 400S = Lightning arrester class I. $80\text{kA (8/20) + dist.sig.}$, $U_N = 400\text{V}$, $I_{max} = 80\text{kA}$, $U_p \leq 2\text{kV}$
- SBN-80 = Encapsulated Gas Discharge Tube 80kA , $U_c = 255\text{V/50 Hz}$, $I_{max} = 120\text{ kA}$, $U_p \leq 1,3\text{ kV}$
- SBN-100 = Encapsulated Gas Discharge Tube 100kA , $U_c = 255\text{V/50Hz}$, $I_{max} = 150\text{kA}$, $U_p \leq 1,5\text{ kV}$
- SZ110 = Encapsulated power spark gap $I_{imp} = 110\text{ kA (L/N)}$, $U_N = 230\text{ V AC}$, $U_p \leq 2,5\text{ kV}$
- SZ110/500 = Encapsulated power spark gap $I_{imp} = 110\text{ kA (L/N)}$, $U_N = 400\text{ V AC}$, $U_p \leq 2,5\text{ kV}$
- SJK110 = Encapsulated power spark gap $I_{imp} = 110\text{ kA (N/PE)}$, $U_c = 255\text{ V AC}$, $I_{max} = 150\text{ kA}$, $U_p \leq 2\text{ kV}$ □



- SBM7-75 = Lightning arrester class I $I_{imp} = 7\text{ kA (10/350)}$, $U_c = 75\text{ V AC}$, $I_{max} = 50\text{ kA}$, $U_p < 350\text{ V}$
- SBM7-75S = Lightning arrester class I $I_{imp} = 7\text{ kA (10/350) dist. sig.}$, $U_c = 75\text{ V AC}$, $I_{max} = 50\text{ kA}$, $U_p < 350\text{ V}$
- SBM7-150 = Lightning arrester class I $I_{imp} = 7\text{ kA (10/350)}$, $U_c = 150\text{ V AC}$, $I_{max} = 50\text{ kA}$, $U_p < 950\text{ V}$
- SBM7-150S = Lightning arrester class I $I_{imp} = 7\text{ kA (10/350) dist. sig.}$, $U_c = 150\text{ V AC}$, $I_{max} = 50\text{ kA}$, $U_p < 950\text{ V}$
- SBM7-275 = Lightning arrester class I $I_{imp} = 7\text{ kA (10/350)}$, $U_c = 275\text{ V AC}$, $I_{max} = 50\text{ kA}$, $U_p < 1,2\text{ kV}$
- SBM7-275S = Lightning arrester class I $I_{imp} = 7\text{ kA (10/350) dist. sig.}$, $U_c = 275\text{ V AC}$, $I_{max} = 50\text{ kA}$, $U_p < 1,2\text{ kV}$
- SBM7-320 = Lightning arrester class I $I_{imp} = 7\text{ kA (10/350)}$, $U_c = 320\text{ V AC}$, $I_{max} = 50\text{ kA}$, $U_p < 1,3\text{ kV}$
- SBM7-320S = Lightning arrester class I $I_{imp} = 7\text{ kA (10/350) dist. sig.}$, $U_c = 320\text{ V AC}$, $I_{max} = 50\text{ kA}$, $U_p < 1,3\text{ kV}$



- SBM7-385 = Lightning arrester class I $I_{imp} = 7 \text{ kA (10/350)}$ $U_c = 385 \text{ V AC}$ $I_{max} = 50 \text{ kA}$ $U_p < 1,5 \text{ kV}$
- SBM7-385S = Lightning arrester class I $I_{imp} = 7 \text{ kA (10/350)}$ dist. sig. $U_c = 385 \text{ V AC}$ $I_{max} = 50 \text{ kA}$ $U_p < 1,5 \text{ kV}$
- SBM7-440 = Lightning arrester class I $I_{imp} = 7 \text{ kA (10/350)}$ $U_c = 440 \text{ V AC}$ $I_{max} = 50 \text{ kA}$ $U_p < 1,7 \text{ kV}$
- SBM7-440S = Lightning arrester class I $I_{imp} = 7 \text{ kA (10/350)}$ dist. sig. $U_c = 440 \text{ V AC}$ $I_{max} = 50 \text{ kA}$ $U_p < 1,7 \text{ kV}$
- SBM12,5-275 = Lightning arrester class I $I_{imp} = 12,5 \text{ kA (10/350)}$ $U_c = 275 \text{ V AC}$ $I_{max} = 100 \text{ kA}$ $U_p < 1,2 \text{ kV}$
- SBM12,5-275S = Lightning arrester class I $I_{imp} = 12,5 \text{ kA (10/350)}$ dist. sig. $U_c = 275 \text{ V AC}$ $I_{max} = 100 \text{ kA}$ $U_p < 1,2 \text{ kV}$
- SBM12,5-320 = Lightning arrester class I $I_{imp} = 12,5 \text{ kA (10/350)}$ $U_c = 320 \text{ V AC}$ $I_{max} = 100 \text{ kA}$ $U_p < 1,3 \text{ kV}$
- SBM12,5-320S = Lightning arrester class I $I_{imp} = 12,5 \text{ kA (10/350)}$ dist. sig. $U_c = 320 \text{ V AC}$ $I_{max} = 100 \text{ kA}$ $U_p < 1,3 \text{ kV}$
- SBM12,5-385 = Lightning arrester class I $I_{imp} = 12,5 \text{ kA (10/350)}$ $U_c = 385 \text{ V AC}$ $I_{max} = 100 \text{ kA}$ $U_p < 1,5 \text{ kV}$
- SBM12,5-385S = Lightning arrester class I $I_{imp} = 12,5 \text{ kA (10/350)}$ dist. sig. $U_c = 385 \text{ V AC}$ $I_{max} = 100 \text{ kA}$ $U_p < 1,5 \text{ kV}$
- SBM12,5-440 = Lightning arrester class I $I_{imp} = 12,5 \text{ kA (10/350)}$ $U_c = 440 \text{ V AC}$ $I_{max} = 100 \text{ kA}$ $U_p < 1,6 \text{ kV}$
- SBM12,5-440S = Lightning arrester class I $I_{imp} = 12,5 \text{ kA (10/350)}$ dist. sig. $U_c = 440 \text{ V AC}$ $I_{max} = 100 \text{ kA}$ $U_p < 1,6 \text{ kV}$
- SBN25 = Encapsulated Gas Discharge Tube 25 kA $U_c = 255 \text{ V AC}$ $I_{max} = 50 \text{ kA}$ $U_p < 1,3 \text{ kV}$
- SBN25P = Encapsulated Gas Discharge Tube 25 kA $U_c = 255 \text{ V AC}$ $I_{max} = 50 \text{ kA}$ $U_p < 1,3 \text{ kV}$

POWER SUPPLY SYSTEMS LIGHTNING ARRESTER CLASS I+II



- SSPC12,5 = 1 Pole Lightning arrester for TNC 12,5 kA (10/350)
- SSPC12,5S = 1 Pole Lightning arrester for TNC 12,5 kA (10/350) + dist.sig.
- SSPC12,5/1+1 = 1 Pole Lightning arrester for TNS or TT
Total Lightning Current 25 kA(10/350)
- SSPC12,5S/1+1S = 1 Pole Lightning arrester for TNS or TT
Total Lightning Current 25 kA(10/350) + dist.sig.
- SSPC12,5/3+0 = 3 Poles Lightning arrester for TNC 12,5 kA (10/350)
Total Lightning Current = 37,5 kA (10/350)
- SSPC12,5S/3+0 = 3 Poles Lightning arrester for TNC 12,5 kA (10/350) + dist.sig.
Total Lightning Current = 37,5 kA (10/350)
- SSPC12,5/3+1 = 3 Poles Lightning arrester for TNS or TT
Total Lightning Current 50 kA(10/350)
- SSPC12,5S/3+1 = 3 Poles Lightning arrester for TNS or TT
Total Lightning Current 50 kA(10/350) + dist.sig.
- SSPC25 = 1 Pole Lightning arrester for TNC 25 kA (10/350)
- SSPC25S = 1 Pole Lightning arrester for TNC 25 kA (10/350) + dist.sig.
- SSPC25/1+1 = 1 Pole Lightning arrester for TNS or TT
Total Lightning Current 50 kA(10/350)
- SSPC25S/1+1S = 1 Pole Lightning arrester for TNS or TT
Total Lightning Current 50 kA(10/350) + dist.sig.
- SSPC25/3+0 = 3 Poles Lightning arrester for TNC 12,5 kA (10/350)
Total Lightning Current = 75 kA (10/350)
- SSPC25S/3+0 = 3 Poles Lightning arrester for TNC 12,5 kA (10/350) + dist.sig.
Total Lightning Current = 75 kA (10/350)
- SSPC25/3+1 = 3 Poles Lightning arrester for TNS or TT
Total Lightning Current 100 kA(10/350)
- SSPC25S/3+1 = 3 Poles Lightning arrester for TNS or TT
Total Lightning Current 100 kA(10/350) + dist.sig.



POWER SUPPLY SYSTEMS LIGHTNING ARRESTER CLASS II



SCF-230



SC-230



SSPU1-240S



SSPU3-240S



SCN-20

- | | |
|---|---|
| SCF - 120 = Surge arrester 20kA (8/20) | SC - 400 = Surge arrester 15kA (8/20) |
| SCF - 230 = Surge arrester 20kA (8/20) | SC- 120 S = Surge arrester 15kA (8/20) + sig. |
| SCF - 280 = Surge arrester 20kA (8/20) | SC - 230 S = Surge arrester 20kA (8/20) + sig. |
| SCF - 400 = Surge arrester 20kA (8/20) | SC - 280 S = Surge arrester 20kA (8/20) + sig. |
| SCF - 120 S = Surge arrester 20kA (8/20) + sig. | SC - 400 S = Surge arrester 15kA (8/20) + sig. |
| SCF - 230 S = Surge arrester 20kA (8/20) + sig. | SCN-20 = Encapsulated Gas Discharge Tube 20kA,
$U_c=255V/50\text{ Hz}, I_{max}=20\text{ kA}, U_p \leq 1,3\text{ kV}$ |
| SCF - 280 S = Surge arrester 20kA (8/20) + sig. | SSPU 1 - 120 = 1 pole, U_N 120V |
| SCF - 400 S = Surge arrester 20kA (8/20) + sig. | SSPU 3 - 240 S = 3 poles, U_N 3x400/230V + sig. |
| SCT - 230 = Surge arrester 15kA (8/20) | SSPU 1 - 240 S = 1 pole, U_N 230V + sig. |
| SCT - 280 = Surge arrester 15kA (8/20) | SSPU 1 - 240 = 1 pole, U_N 230V |
| SCT - 230 S = Surge arrester 15kA (8/20) + sig. | SSPU 3 - 240 = 3 poles, U_N 3x400/230V |
| SCT - 280 S = Surge arrester 15kA (8/20) + sig. | SSPU 3 - 120 = 3 poles, U_N 3x208/120V |
| SC - 120 = Surge arrester 15kA (8/20) | SSPU 3 - 400 = 3 poles, U_N 3x680/400V |
| SC - 230 = Surge arrester 20kA (8/20) | SPR 100 = Helping Connection Module |
| SC - 280 = Surge arrester 20kA (8/20) | |

POWER SUPPLY SYSTEMS LIGHTNING ARRESTER CLASS III



SDL-32HFF



SDL-16HFF

SDL-25HFF



SDL-25HFFS



SD-16



SDI-16

- | |
|---|
| SDLTN = One phase protection for 230V |
| SDL-25RFIS = Surge arrester 8kA (8/20), 230V, 25A + sig. |
| SDL-8HFF = Surge arrester 8kA (8/20), 230V, 8A |
| SDL-16HFF = Surge arrester 8kA (8/20), 230V, 16A |
| SDL-16HFFS = Surge arrester 8kA (8/20), 230V, 16A + sig. |
| SDL-25HFF = Surge arrester 8kA (8/20), 230V, 25A |
| SDL-25HFFS = Surge arrester 8kA (8/20), 230V, 25A + sig. |
| SDL-25RFIS = Surge arrester 8kA (8/20), 230V, 25A + sig. |
| SDL-32HFF = Surge arrester 8kA (8/20), 230V, 32A |
| SDL-32HFFS = Surge arrester 8kA (8/20), 230V, 32A + sig. |
| SDL-50HFF = Surge arrester 8kA (8/20), 230V, 50A |
| SDL-63HFF = Surge arrester 8kA (8/20), 230V, 63A |
| SDL-80HFF = Surge arrester 8kA (8/20), 230V, 80A |
| SDL-120HFF = Surge arrester 8kA (8/20), 230V, 120A |
| SDL-150HFF = Surge arrester 8kA (8/20), 230V, 150A |
| SDL-16/400HFF = Surge arrester 8kA (8/20), 400V, 16A |
| SDL-16/400HFFS = Surge arrester 8kA (8/20), 400V, 16A + sig. |
| SDL- 316HFFS = Surge arrester 8kA (8/20), 3x400/230V, 16A +sig |
| SDL- 325HFFS = Surge arrester 8kA (8/20), 3x400/230V, 25A +sig |
| SDL- 332HFFS = Surge arrester 8kA (8/20), 3x400/230V, 32A +sig |
| SDL- 350HFFS = Surge arrester 8kA (8/20), 3x400/230V, 50A +sig |
| SDL- 363HFFS = Surge arrester 8kA (8/20), 3x400/230V, 63A +sig |
| SDL- 380HFFS = Surge arrester 8kA (8/20), 3x400/230V, 80A +sig |
| SDI- 16 = Protected socket, 8kA (8/20), 16A |
| SD- 4 = Protected socket with high freq. filter, 8kA (8/20), 6A |
| SD- 16 = Protected socket with high freq. filter, 8kA (8/20), 16A |
| SD-FAXRJ12 = Combined protection of suply and telephone network |



SCHIRTEC®

COMPUTER NETWORK PROTECTION



SD 2/100M - 5 cat
SD 4/100M - 5 cat



SD 4/100M - 5 cat



SD 2/100M - 5 cat

SD 2/100M - 5 cat = Module for PC systems for 5 cat
 SD 1/100M - 5 cat = Module for PC systems for 5 cat
 SD 4/100M - 5 cat = Module for PC systems for 5 cat
 SCHIRTECNET 1. 2RJ/RJ = Module for PC systems for 5 cat

SPSK 10 = Metal box
 SPSK 2/100M - 5 cat = Module for 2 pairs
 SPSK 4/100M - 5 cat = Module for 4 pairs
 SPSK 24 = Metal box

SCHIRTECNET 8. RJ/RJ = Module for 8 stations, input and output RJ 45
 SCHIRTECNET 8.*XC/RJ = Module for 8 stations, input XC and output RJ 45
 SCHIRTECTEL 8.1 RJ/RJ = Module for 8 stations, input and output RJ 45
 SCHIRTECTEL 8.2 RJ/RJ = Module for 8 stations, input and output RJ 45
 SCHIRTECTEL 8.1 LSA/RJ = Module for 8 stations, input LSA-plus and output RJ 45
 SCHIRTECTEL 8.2 LSA/RJ = Module for 8 stations, input LSA-plus and output RJ 45

COAXIAL PROTECTION



SCO-1G
SCO-2G



SCO-1P
SCO-2P



SCO-10P



SCO-7/16

SCO - 1P = for BNC connector
 SCO - 2P = for BNC connector
 SCO - 9P = for F connector
 SCO - 10P = TV connector
 SCO - 3GN (F/F) = for N connector
 SCO - 3GN (F/M) = for N connector
 SCO - 4GN (F/F) = for N connector
 SCO - 4GN (F/M) = for N connector
 SCO-1G = for BNC connector
 SCO-2G = for BNC connector
 SCO-9G = for F connector
 SCO-10G = TV connector
 SCO-11G = for UHF connector
 SCO-12G = for UHF connector
 SCO-7/16 = 7/16 connector (F/F)

INSULATION LEVEL DROP DETECTOR



SIS-71



CE-500

SIS 71 = Ins. level drop detector AC IT system (10-210kW)
 SIS 72 = Ins. level drop detector AC IT system (1-9kW)
 CE 500 = Inductor 3x500V

EQUIPOTENTIAL BONDING (HIGH POWER GAS DISCHARGE TUBE)



SGDT-100-RW



SGDT-100

SGDT-150-RW1
SGDT-150-RW2

SGDT-100 = Isolating Spark Gap, $I_{imp} = 100$ kA
 SGDT-100-Ex = Ex Isolating Spark Gap, $I_{imp} = 100$ kA
 SGDT-100-RW = Ex Isolating Spark Gap, $I_{imp} = 100$ kA

(Isolating Spark Gap for Railway systems, $I_{imp} = 150$ kA)



SURGE PROTECTION SYSTEMS

Home and Office Application

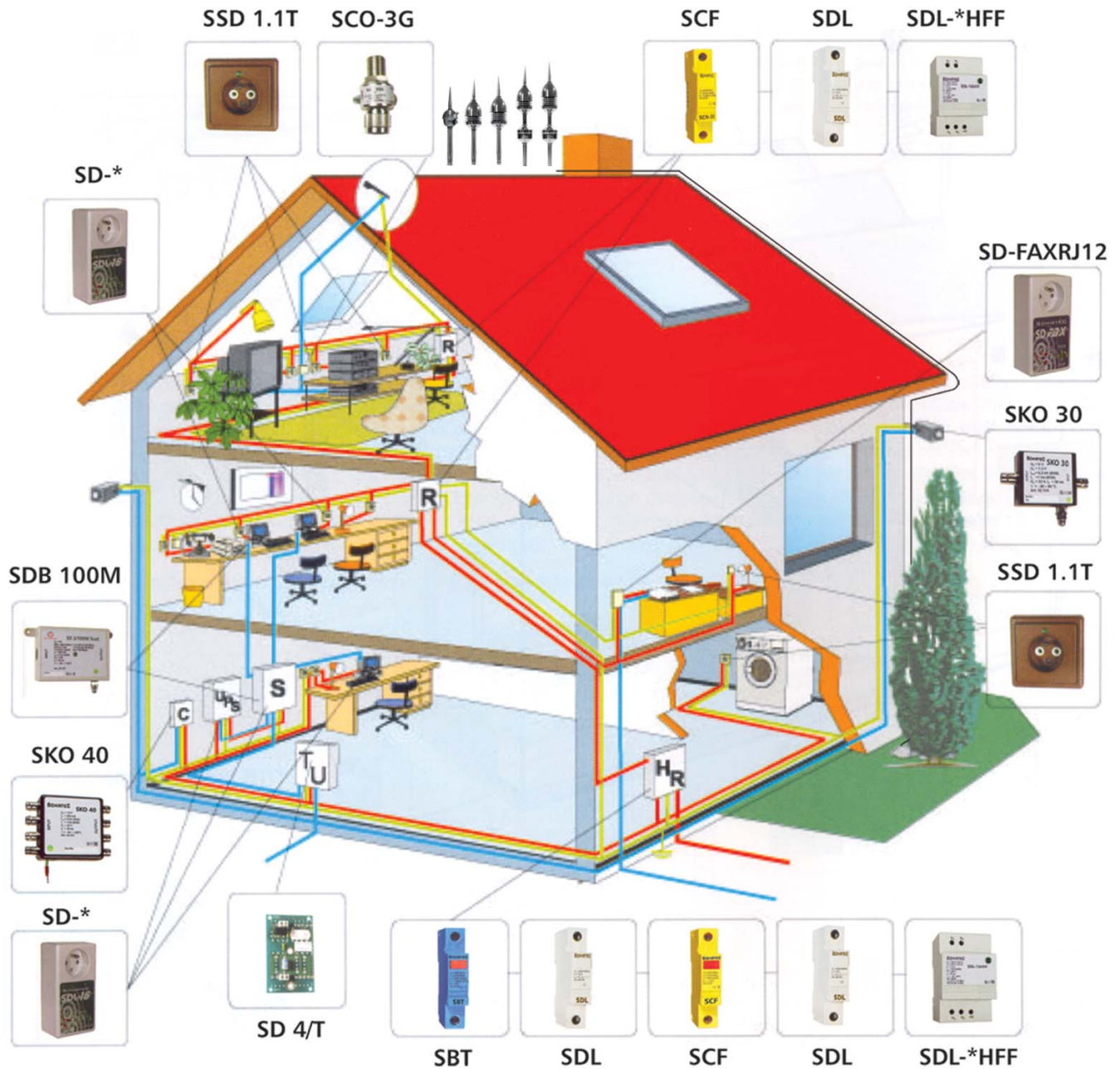

HR - Main switchboard
 R - Subdistribution switchboard
 TU - Tel. central
 C - Security central
 S - Server computer



SCHIRTEC®



Created For Your Safety



ICMET



Staatliche Versuchsanstalt

SCHIRTEC AG

Ignaz-Köck Strasse 10,
1210 Wien/Austria

Ph: +43 1 2703347 11 Fax: +43 1 2703347 49

www.schirtec.at e-mail: info@schirtec.at